

➤ Instructions

Thule Approach Annex 901019, 901020, 901021

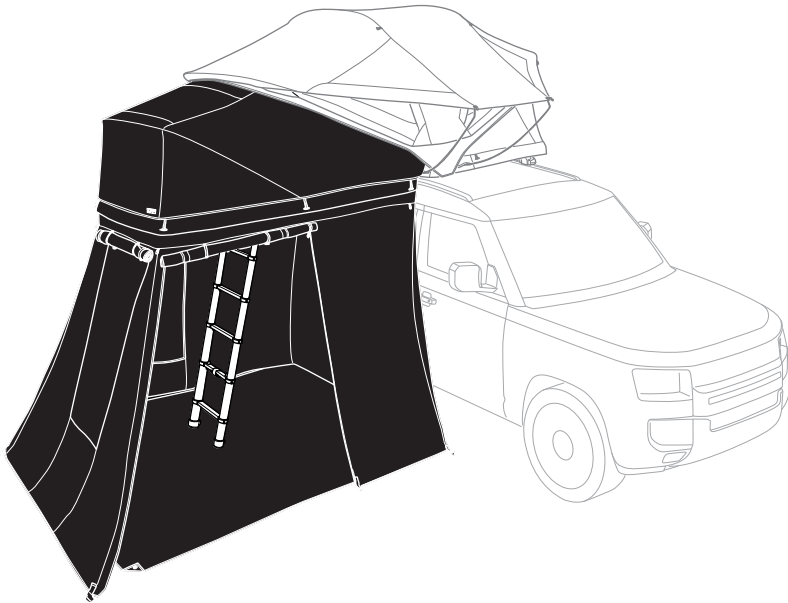

THULE.COM

➤ **Video Instructions**
Thule Approach Annex



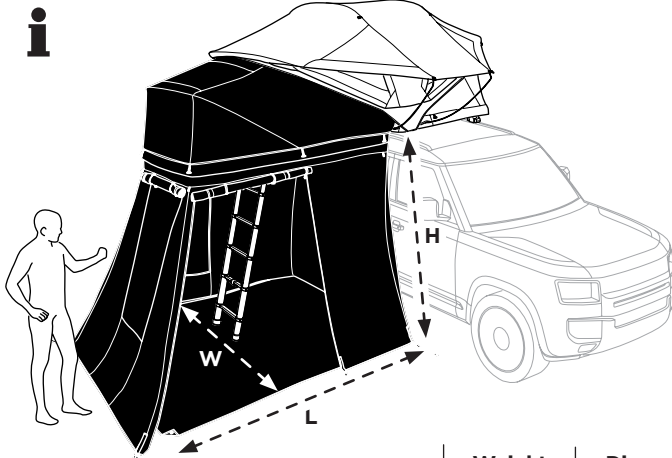
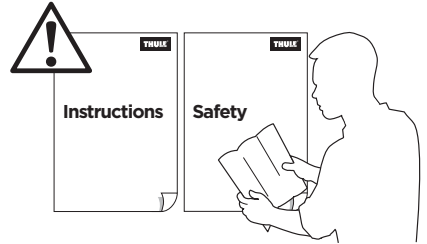
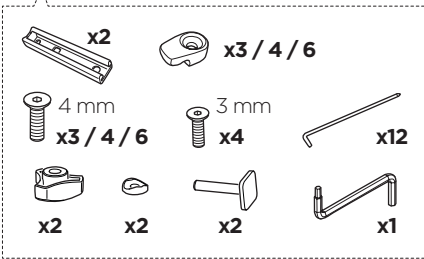
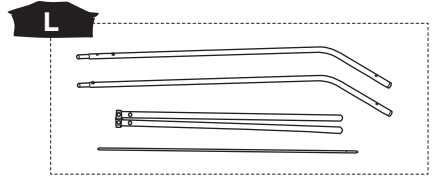
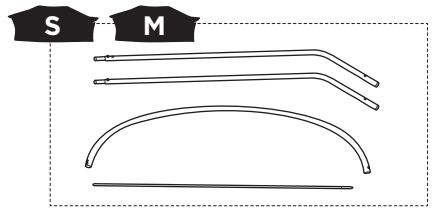
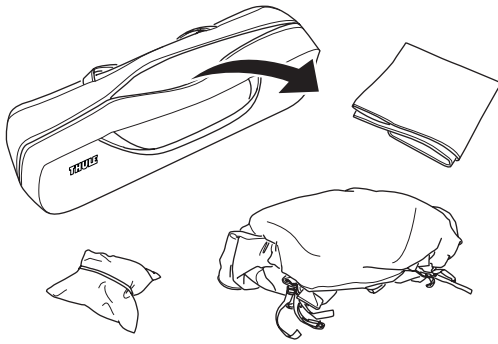

	Weight	Dimensions Floor L x W	Height
S Thule Approach Annex S 901019	6.2 kg 13.7 lbs	187 x 201 cm 74 x 79 in	165 - 215 cm 65 - 85 in
M Thule Approach Annex M 901020	7.3 kg 16.1 lbs	203 x 220 cm 80 x 87 in	165 - 215 cm 65 - 85 in
L Thule Approach Annex L 901021	7.7 kg 17 lbs	253 x 220 cm 99 x 87 in	165 - 215 cm 65 - 85 in

1

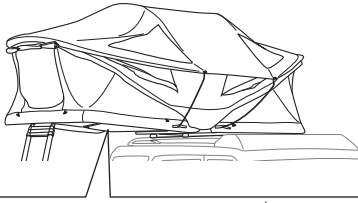

S



M



L

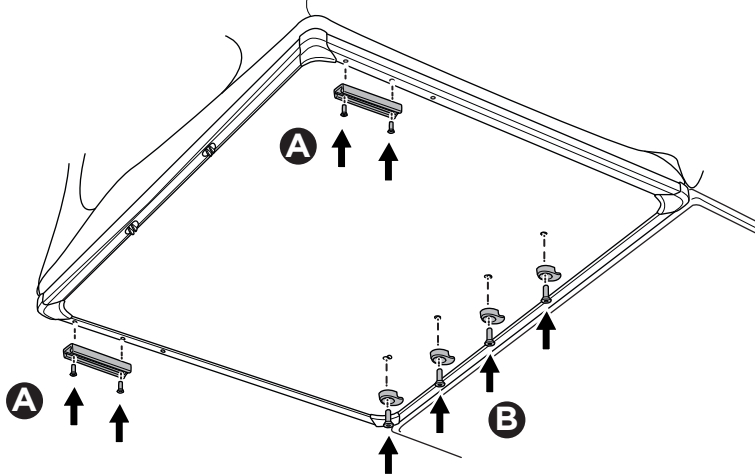
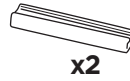

A

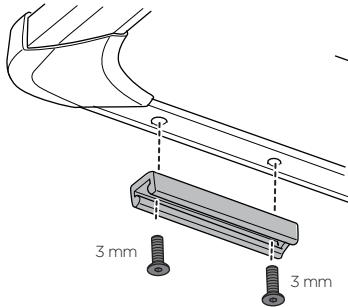

B

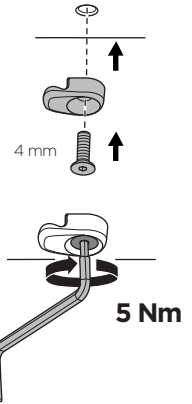

i

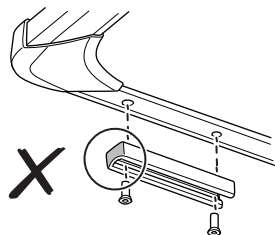
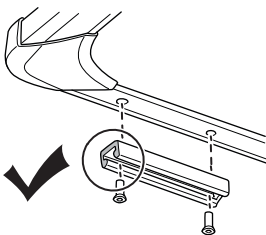

2

A

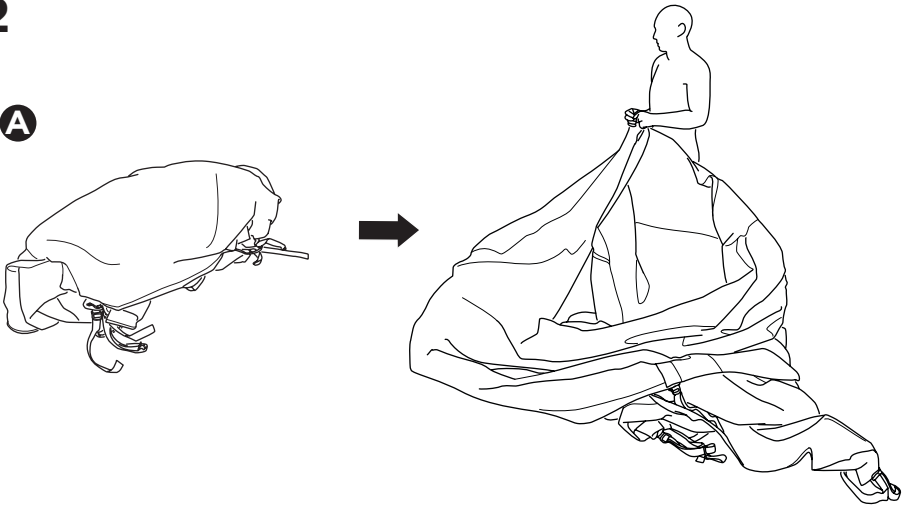

B

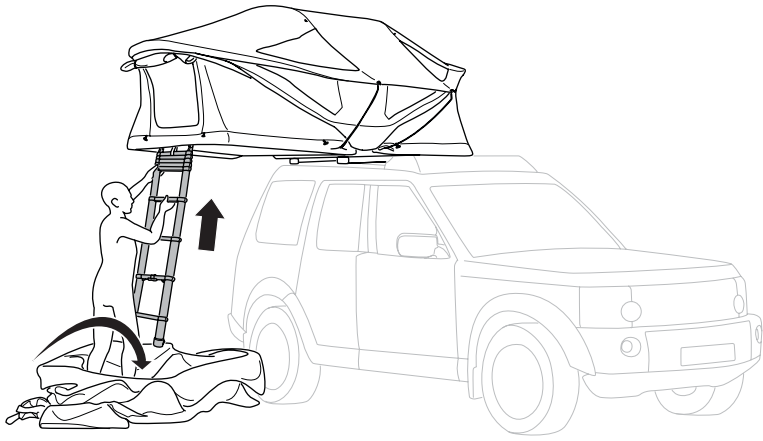

C



3

A

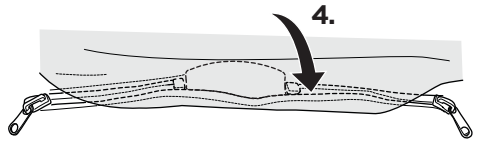
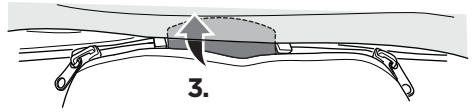
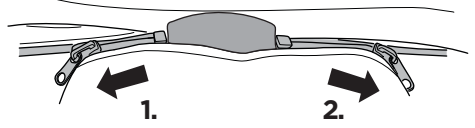
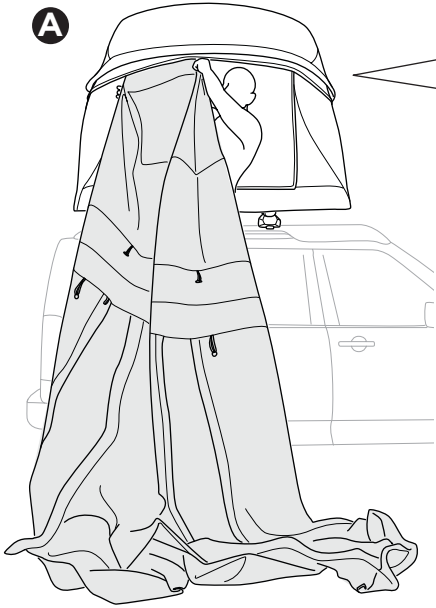

B

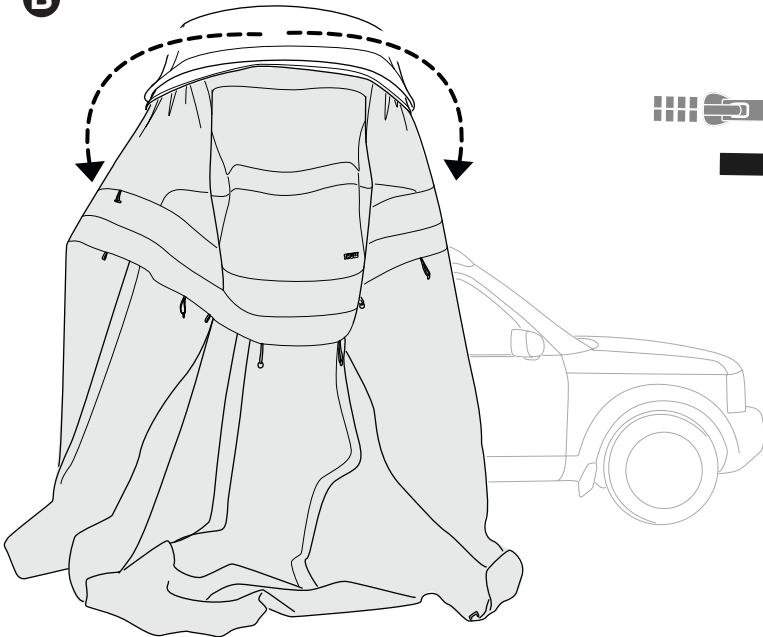

4

L



A

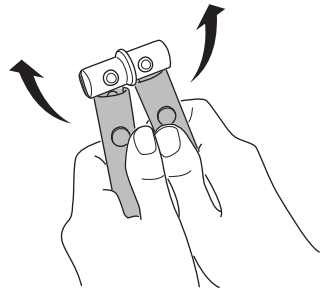
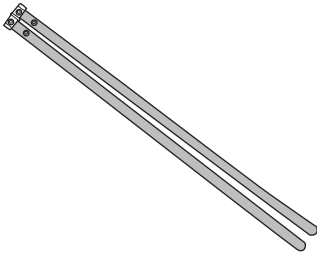

B

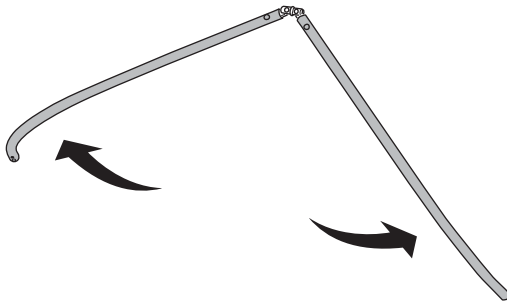

C

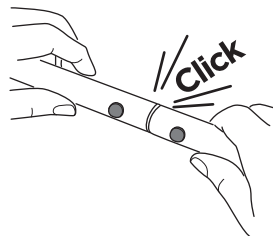
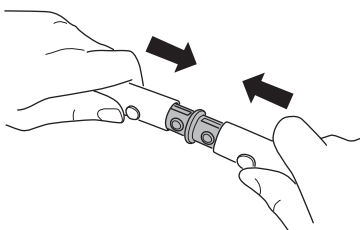
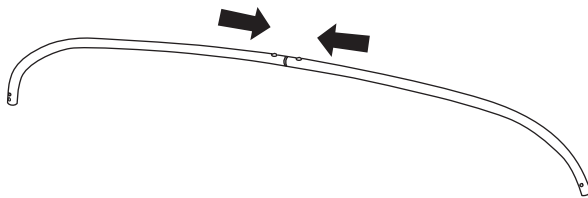

5

S M L

A

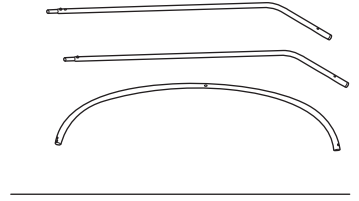
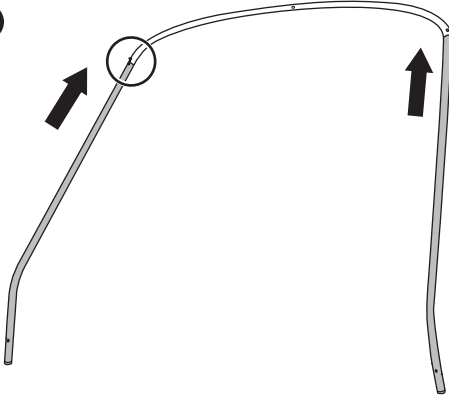

B

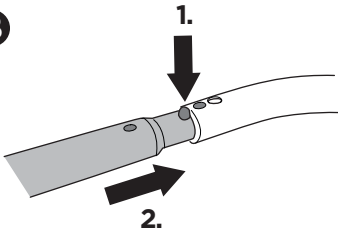

C

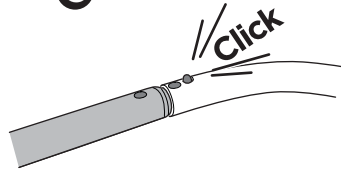

i

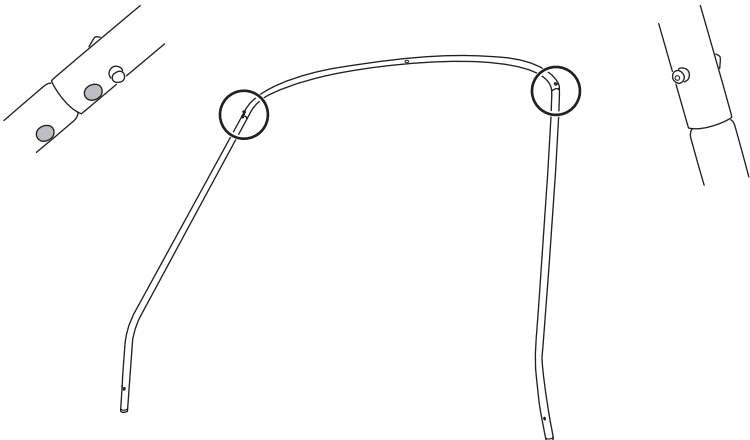

6

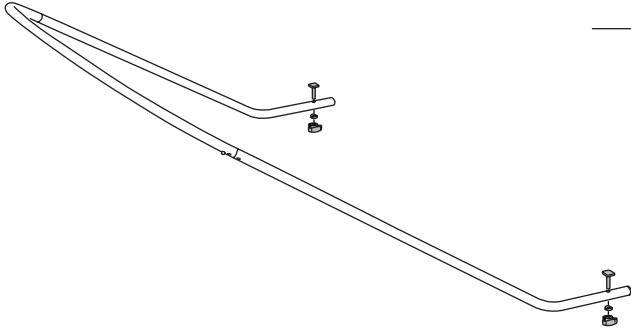

A

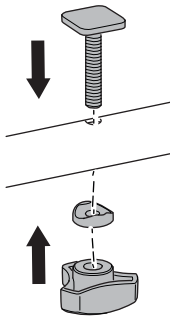

B

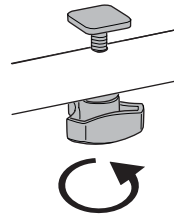

7

A



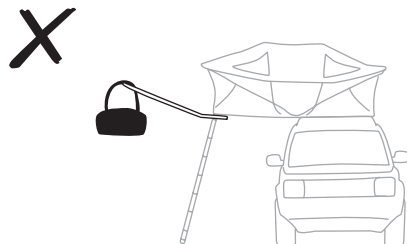
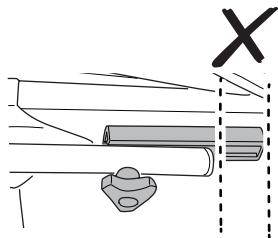
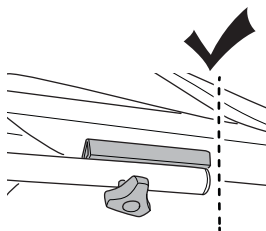
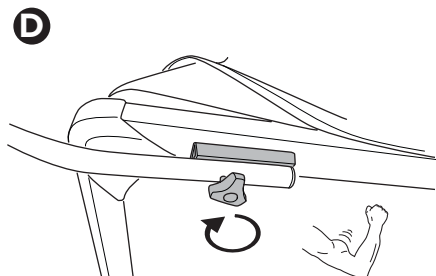
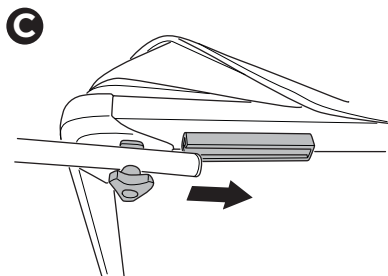
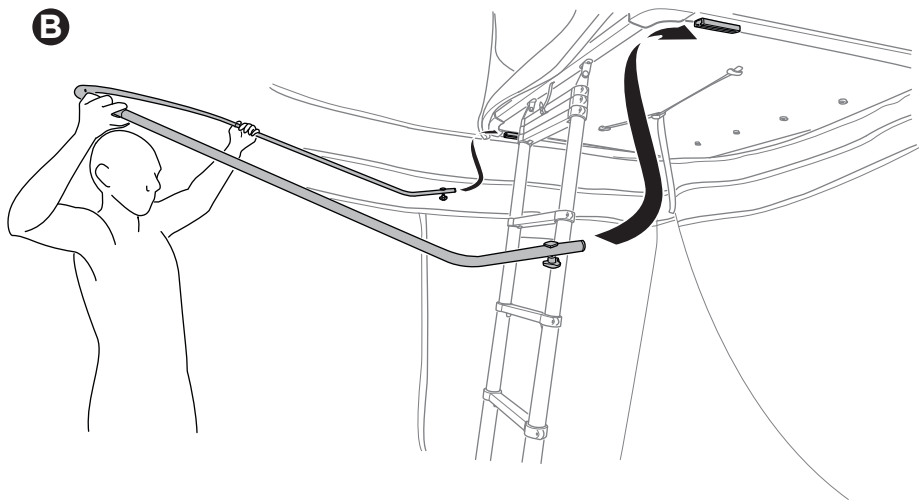

8

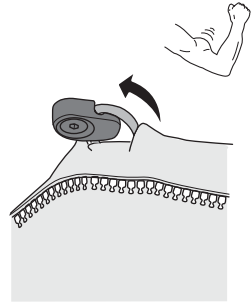
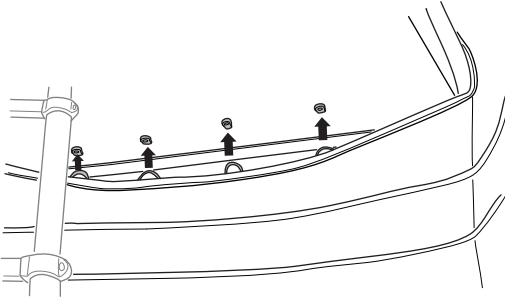
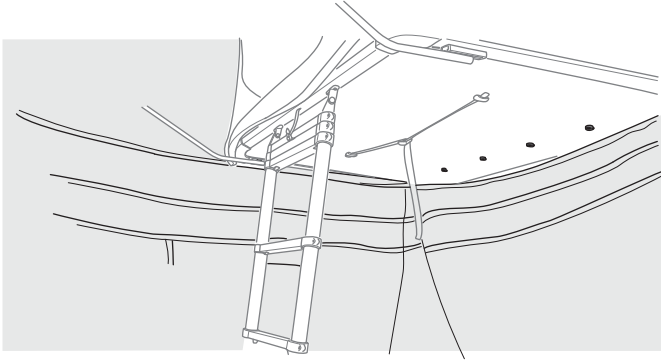

x4

i



Max

20 kg
44 lbs

i

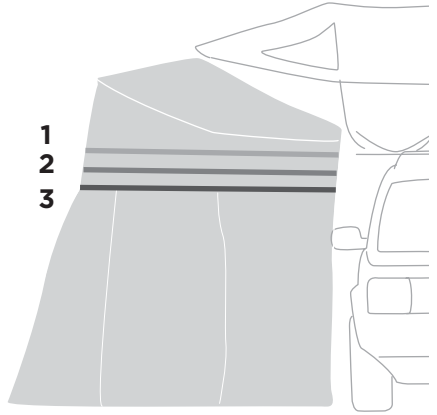
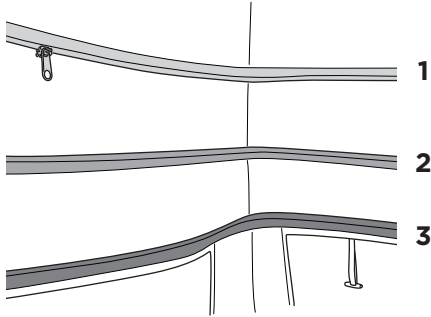
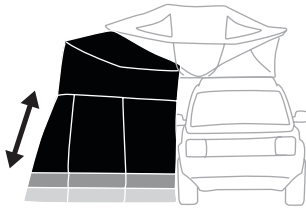

i

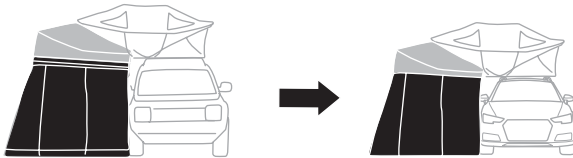

A

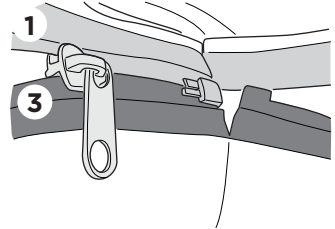
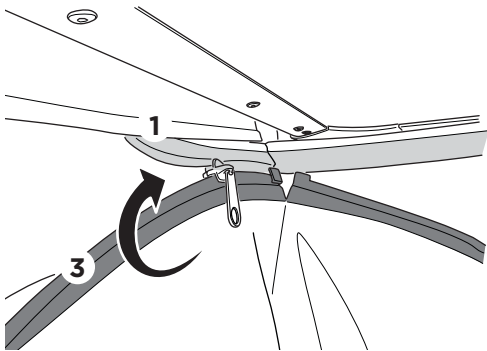

B

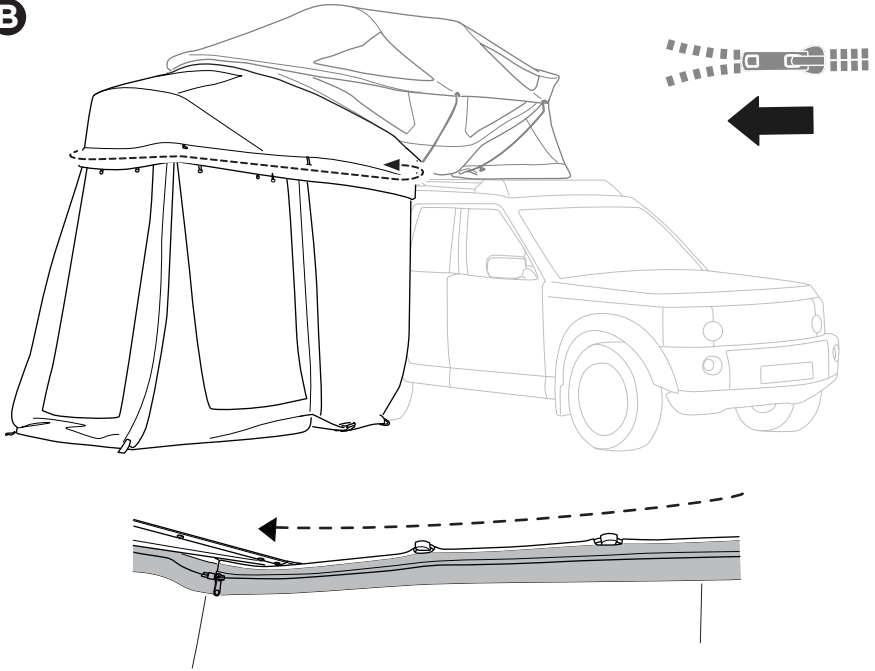

9



A

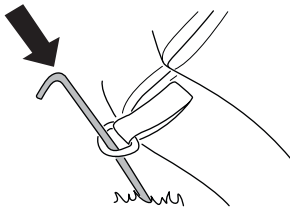

B

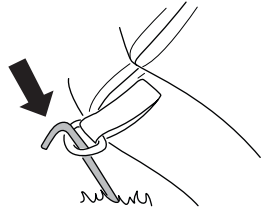

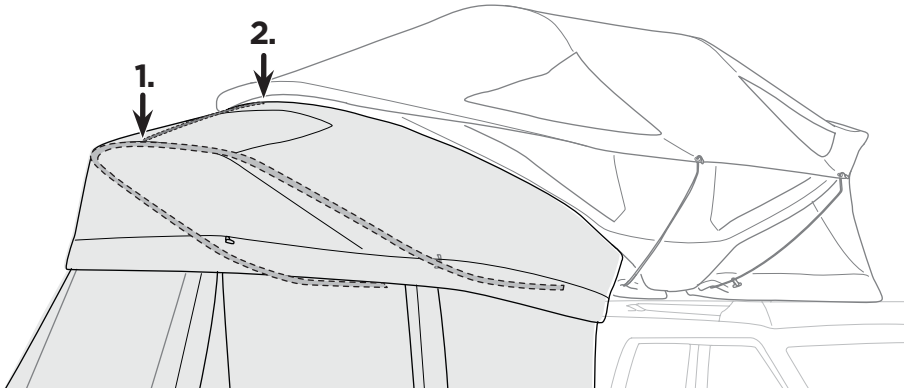

1.

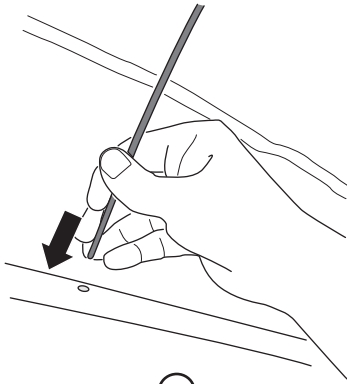

2.

A

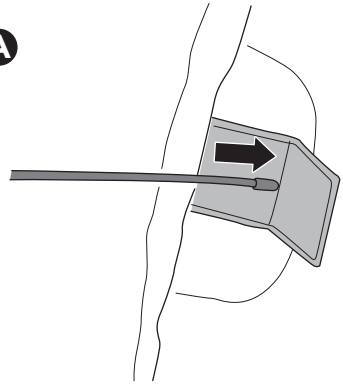

B

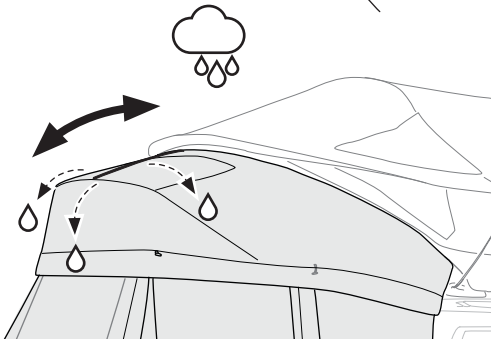
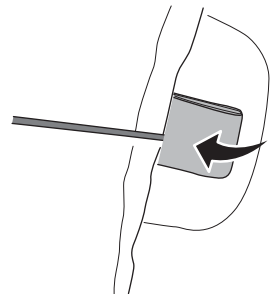

i

A



B

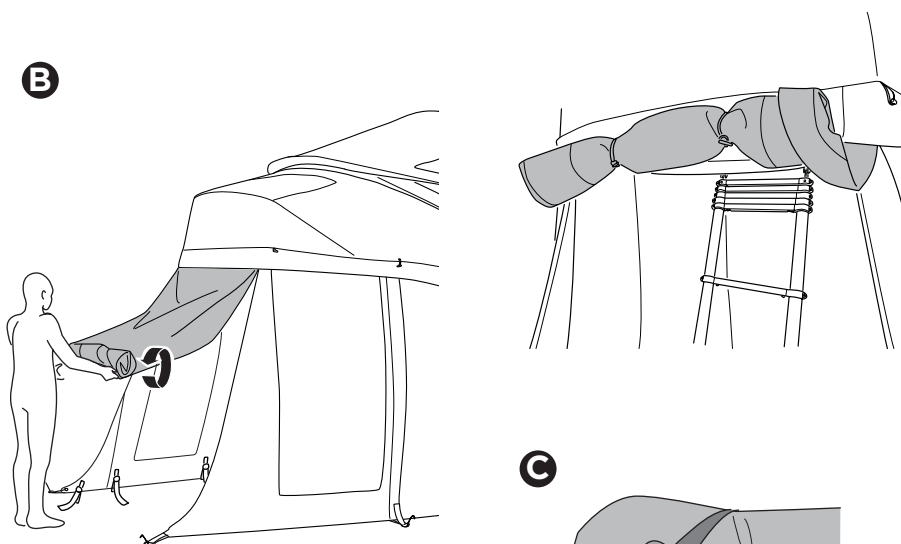

C

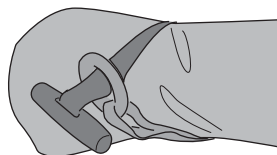

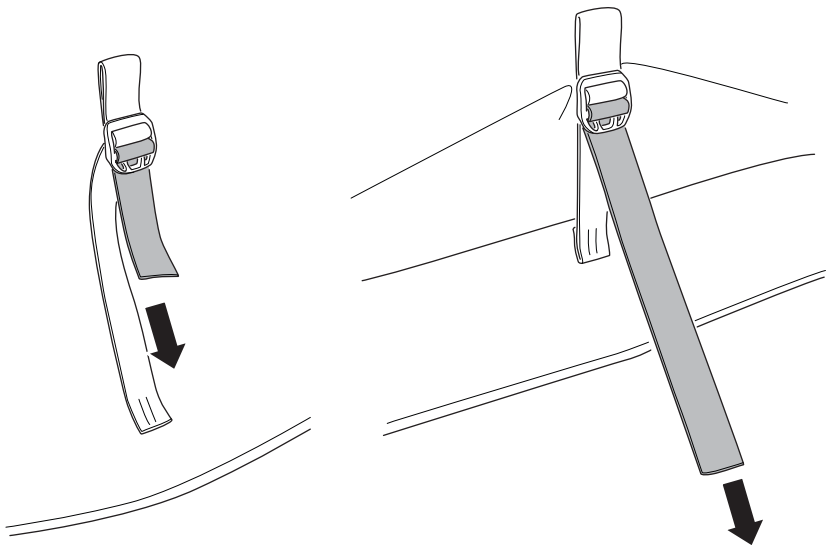

i

A

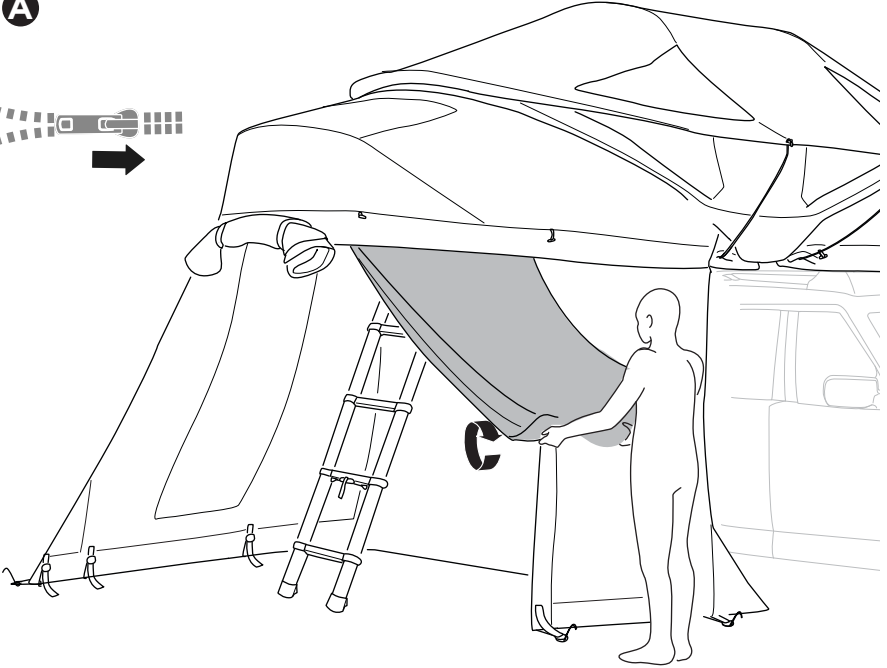

B



C

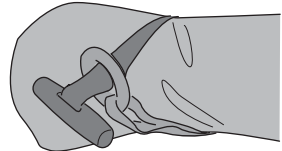

i

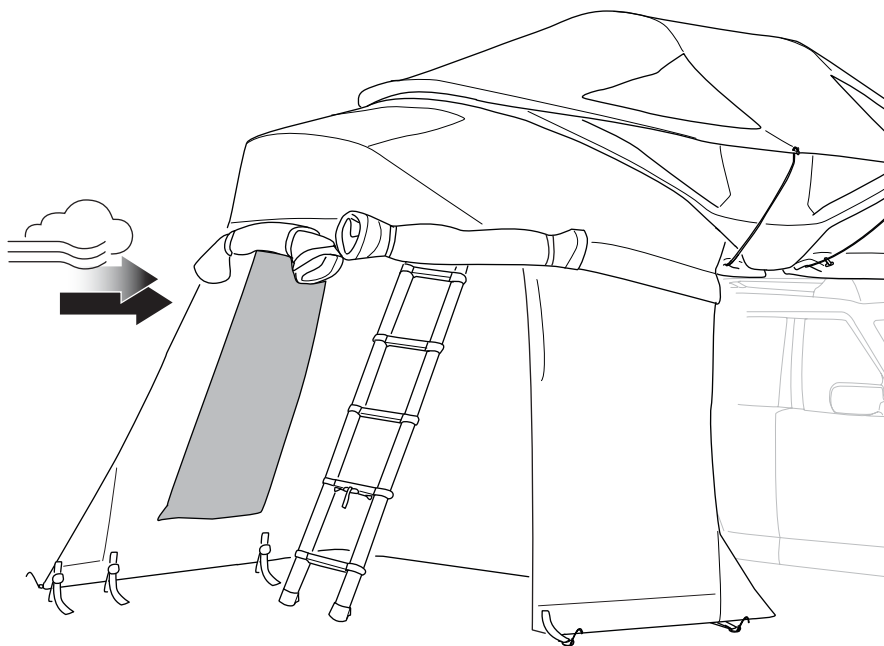

A

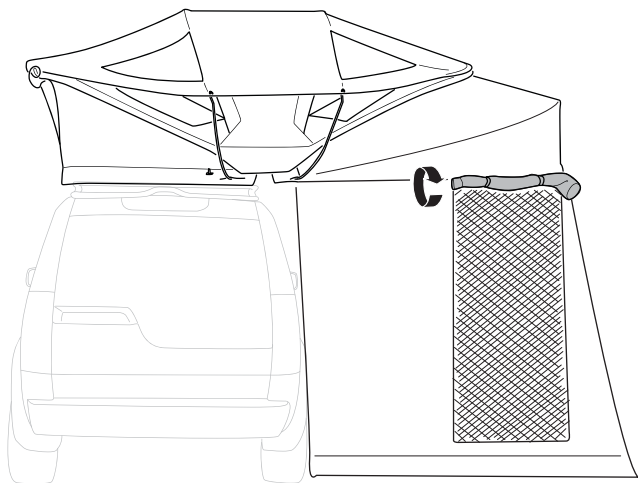

B



C

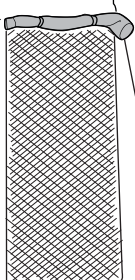

12

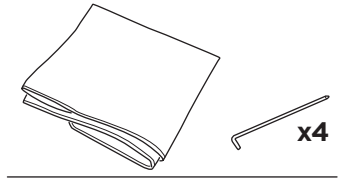

A



B

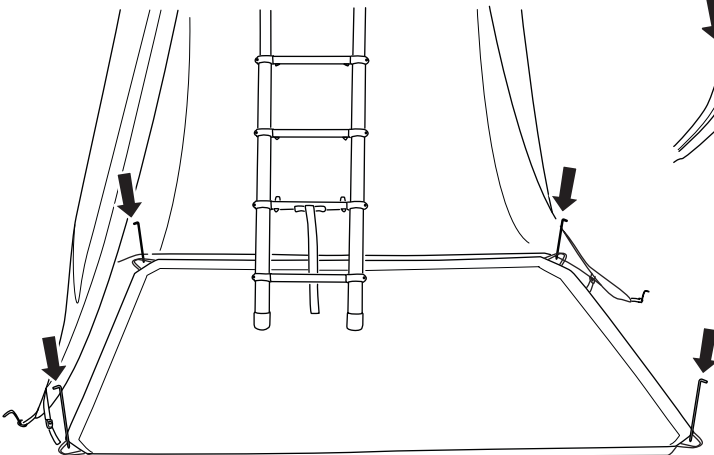

C

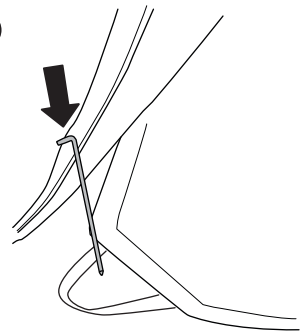

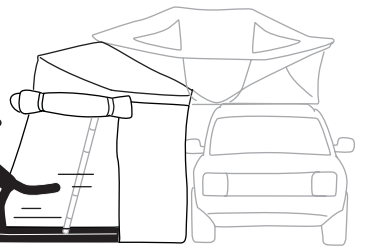
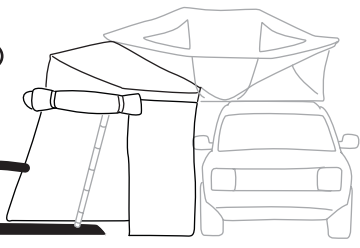
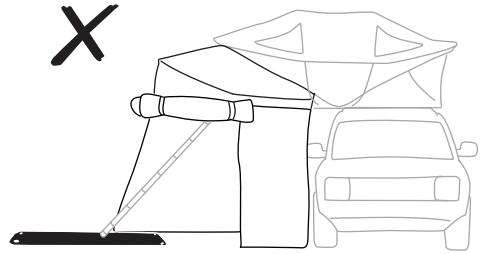
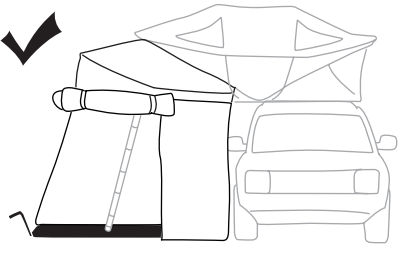

i

