

# ➤ Instructions

Thule Yepp Nexxt 2 Mini  
1208012X



**EN** Front Child Bike Seat  
**FR** Siège vélo enfant avant  
**ES** Asiento para niños en la parte delantera de la bicicleta  
**DE** Vorne montierter Fahrradkindersitz  
**NL** Fietszitje voor voorop  
**PT** Cadeirainha infantil dianteira para bicicleta  
**IT** Seggiolino anteriore per bambini  
**SV** Frontmonterad cykelbarnstol  
**DK** Foranmonteret cykelstol  
**NO** Frontmontert barnesete til sykkel  
**FI** Eteen kiinnitettävä polkupyörän lastenistuin  
**IS** Barnasæti framan á reiðhjól  
**ET** Eesmine jalgratta lasteiste  
**LV** Velosipēda priekšējais bērna sēdekļis  
**LT** Priekinė vaikiška dviračio kėdutė  
**RU** Переднее детское велосипедное сиденье  
**UK** Передне дитяче велосипедне крісло  
**PL** Przedni rowerowy fotelik dziecięcy

**CS** Přední dětská cyklosedačka  
**HU** Kerékpáros első gyerekülés  
**RO** Scaun față de copii pentru bicicletă  
**SK** Predná detská cyklosedačka  
**SL** Sprednji otroški kolesarski sedež  
**BG** Предна детска седалка за велосипед  
**HR** Dječja sjedalica za bicikl koja se postavlja sprijeda  
**EL** Μπροστινό παιδικό κάθισμα ποδηλάτου  
**TR** Öne Bağlanan Çocuk Bisiklet Koltuğu  
**MT** Sedil tar-Rota għat-Tfal li Jitpoġġa Quddiem

מושב אופניים קדמי לילד  
 مقعد الدراجة الأمامي للطفل **HE** **AR**

**ZH (CN)** 前置式儿童自行车座椅  
**ZH (TW)** 前置式自行車兒童座椅  
**JA** サイクル前部用チャイルドシート  
**KO** 전면 어린이 자전거 시트  
**TH** เก้าอี้เด็กสำหรับติดตั้งหน้าจักรยาน  
**MS** Tempat Duduk Basikal Kanak-kanak Depan

## EN 14344:2022

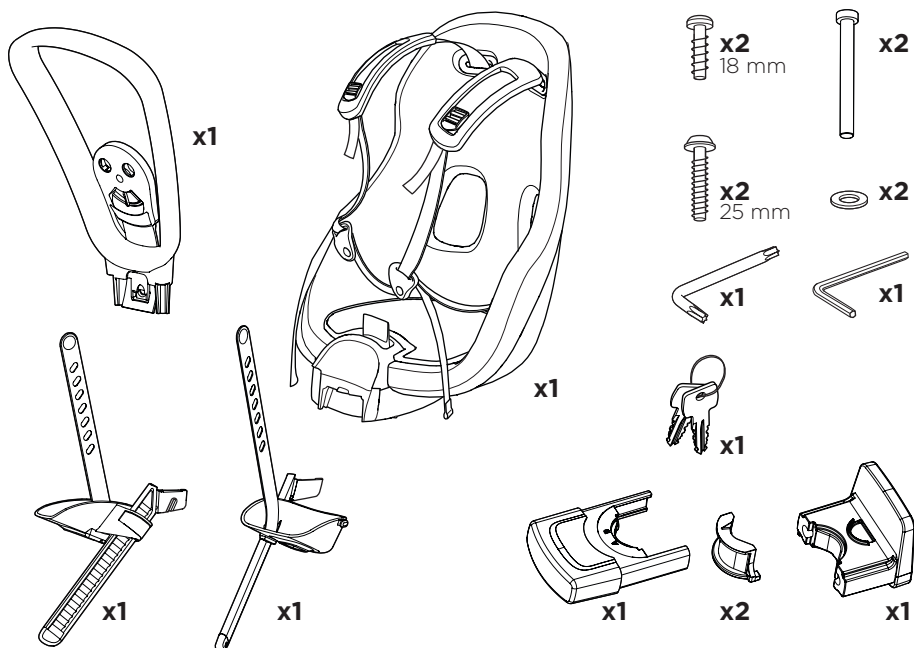

- EN** Please read the following instructions carefully and keep them for future reference.
- DE** Bitte die folgenden Anleitung aufmerksam durch und bewahren Sie sie zum späteren Nachschlagen auf.
- FR** Veuillez lire attentivement les instructions suivantes et les conserver pour référence future.
- NL** Dient u zorgvuldig de volgende instructies te lezen en deze als toekomstig naslagwerk te bewaren.
- IT** Leggi le seguenti istruzioni attentamente e conservale per consultazioni future.
- ES** Lea las instrucciones siguientes atentamente y guárdelas para consultas posteriores.
- PT** Leia cuidadosamente as instruções a seguir e guarde-as para referência futura.
- SV** Vi ber dig läsa följande instruktioner noggrant och därefter behålla dem för framtida bruk.
- DK** Skål du læse følgende anvisninger grundigt igennem og gemme dem til fremtidig reference.
- NO** Bør du lese disse instruksjonene nøye. Ta vare på dem i tilfelle du får bruk for dem senere.
- FI** Lue seuraavat ohjeet huolellisesti. Pidä ohjeet tallessa.
- IS** Lestu þessar leiðbeiningar vandlega áður en þú og geymdu þær til síðari nota.
- ET** kasutuselevõttu lugege järgmised juhised hoolikalt läbi ja hoidke need alles.
- LV** lūdzu, izlasiet uzmanīgi tālāk sniegtos norādījumus un saglabājiet tos turpmākai izmantošanai.
- LT** atidžiai perskaitykite toliau pateiktas instrukcijas ir jų neišmeskite, kad galėtumėte peržiūrėti ateityje.
- PL** należy dokładnie przeczytać następujące instrukcje i zachować je do wykorzystania w przyszłości.
- RU** внимательно изучите представленные ниже инструкции и сохраните их для дальнейшего использования.
- UK** ознайомтеся з нижченаведеними інструкціями й зберігайте їх для довідки в майбутньому.
- BG** прочетете внимателно следните инструкции и ги запазете за бъдещи справки.
- CS** si pečlivě přečtete následující pokyny a uložte si je, abyste se k nim mohli kdykoli vrátit.
- SK** si pozorne prečítajte nasledujúce pokyny a uložte si ich, aby ste sa k nim mohli kedykoľvek vrátiť.
- SL** skrbno preberite navodila v nadaljevanju in jih shranite.
- HR** pažljivo pročitajte sljedeće upute i sačuvajte ih za buduću uporabu.
- RO** citiți cu atenție următoarele instrucțiuni și păstrați-le pentru consultare ulterioară.
- HU** használatbavétele előtt figyelmesen olvassa el az alábbi tudnivalókat, és tartsa azokat később is hozzáférhető helyen
- EL** διαβάστε προσεκτικά τις παρακάτω οδηγίες και φυλάξτε τις για μελλοντική αναφορά.
- TR** kullanmadan önce aşağıdaki talimatları dikkatle okuyun ve gelecekte başvurmak amacıyla saklayın.
- MT** jekk jogħġbok aqra l-istruzzjonijiet li ġejjin bir-reqqa u zommhom għal referenza futura.

**HE** קרא את ההוראות להלן בקפידה ושומר עליהן לעיון במועד מאוחר יותר.  
**AR** يرجى قراءة التعليمات التالية بعناية والاحتفاظ بها للرجوع إليها في المستقبل.

**ZH (CN)** 请仔细阅读以下说明，并保留该说明以供日后参考。

**ZH (TW)** 請詳閱以下說明，並妥善保管以便未來參考使用。

**JA** をご利用になる前に、以下の手順を最後までお読みいただき、今後も参照できるように保管してください。

**KO** 을 사용하기 전에 다음 지침을 잘 읽고 나중에 참고할 수 있도록 보관해 주십시오.

**TH** โปรดอ่านคำแนะนำต่อไปนี้อย่างละเอียดและเก็บไว้เพื่อใช้อ้างอิงในอนาคต

**MS** sila baca arahan berikut dengan teliti dan simpan arahan ini untuk rujukan masa hadapan.

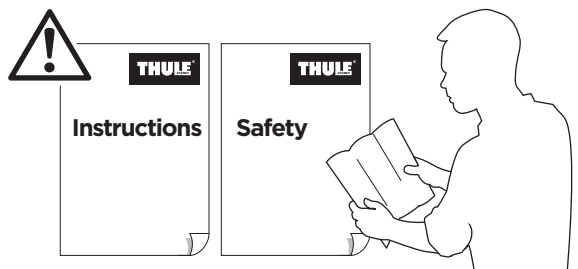





9-36 M
9-15 kg 20-33 lbs
93 cm 36.61 inch



Your Key-Number

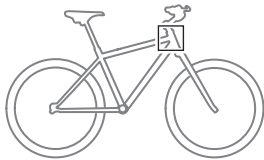

0-9 M



Min:  
21 mm  
0.83 inch

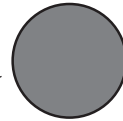
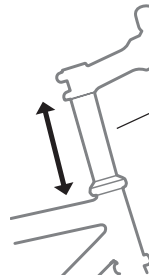

Ø 22-28 mm  
Ø 0.87-1.10 inch

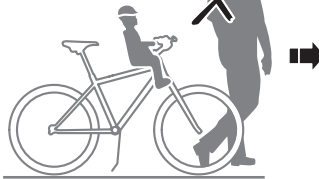

Max. 25 km/h  
15 mph

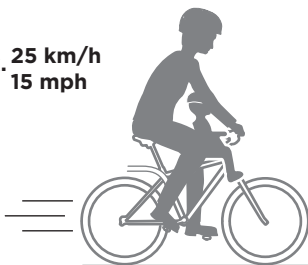

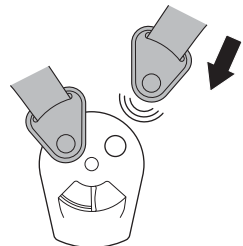
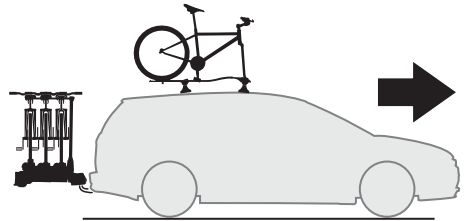
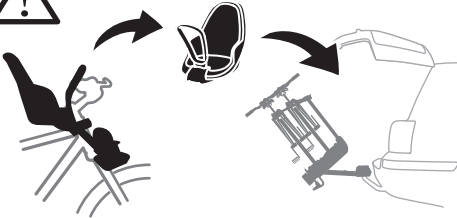
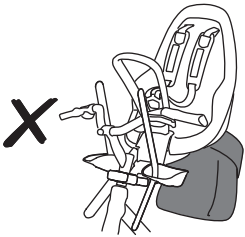
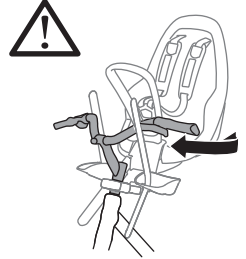



1

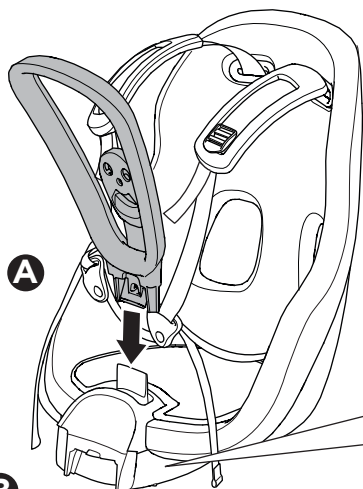

A

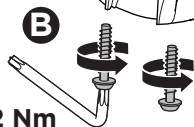

2 Nm



25 mm

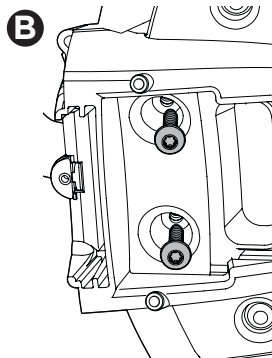

B

2

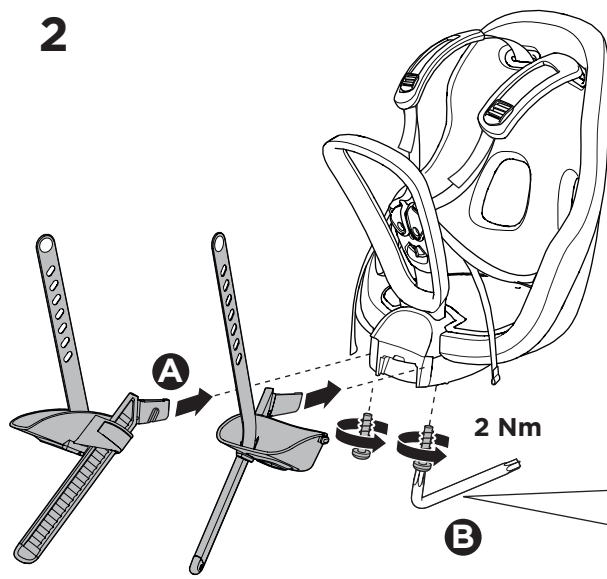

A

2 Nm

B

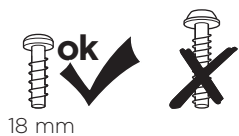

18 mm

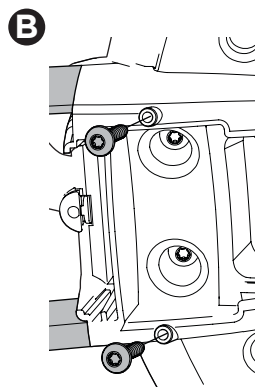

B

3

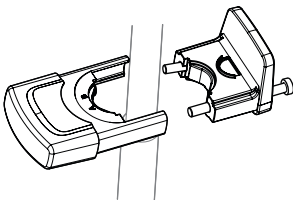
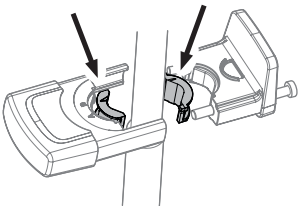
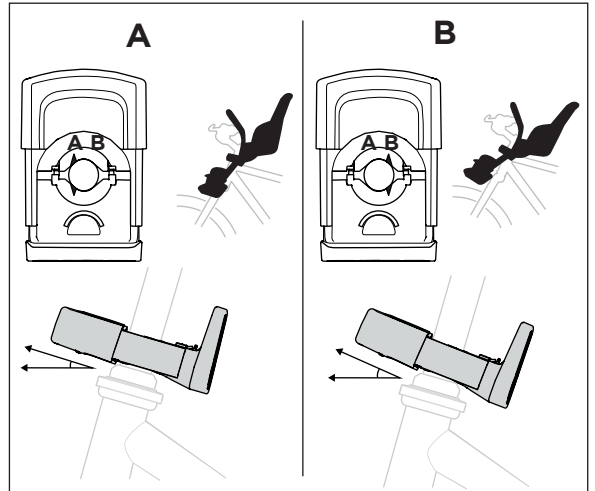
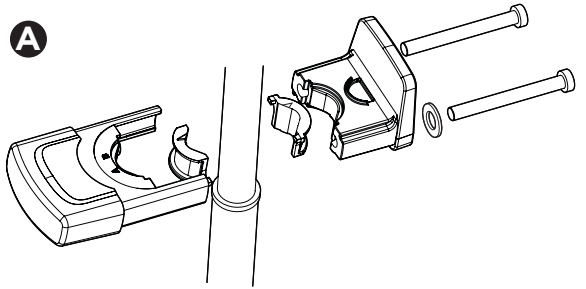
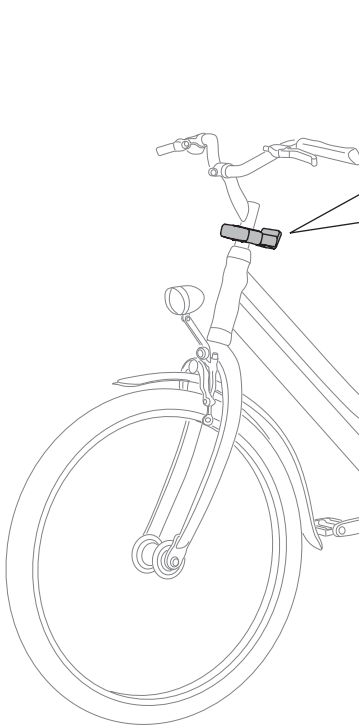
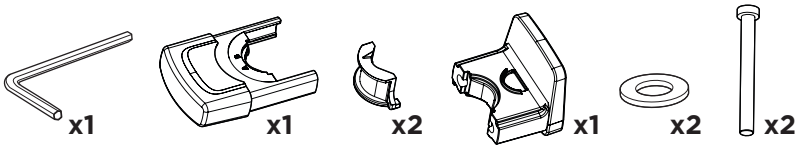

B

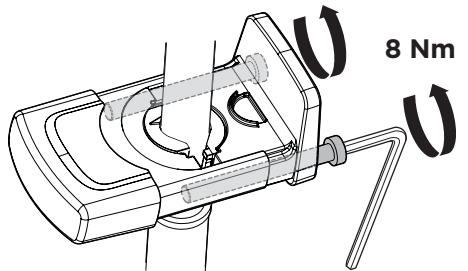

4

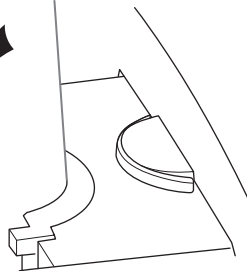
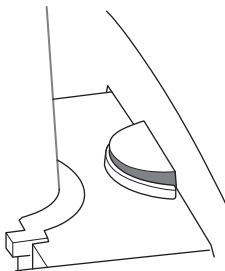
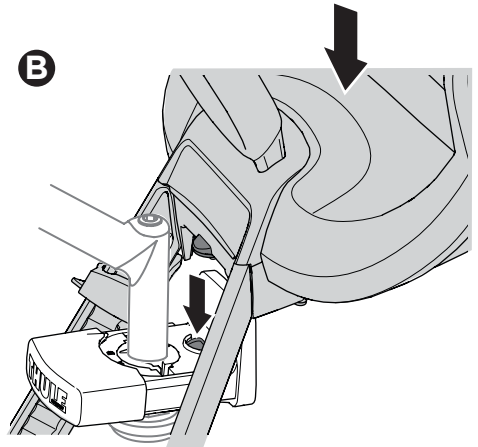
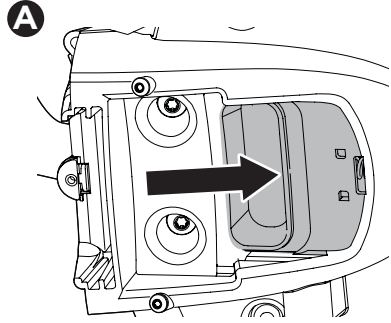
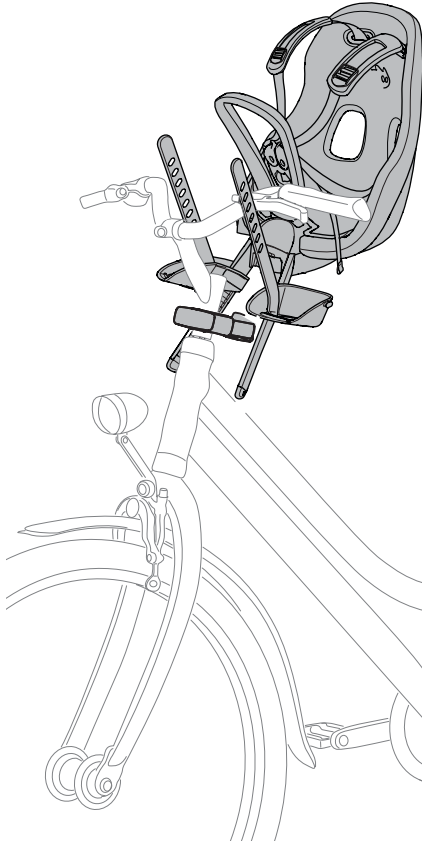



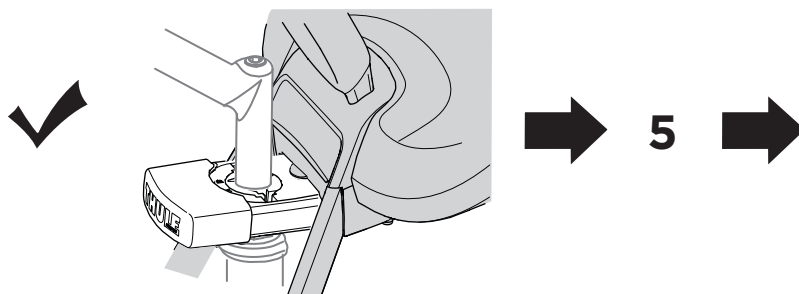
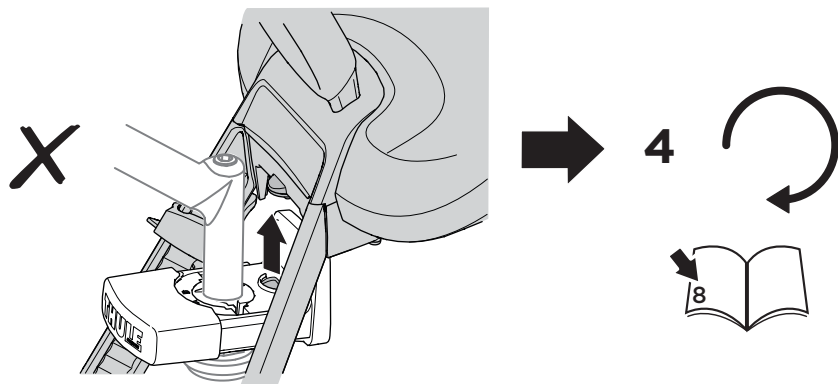
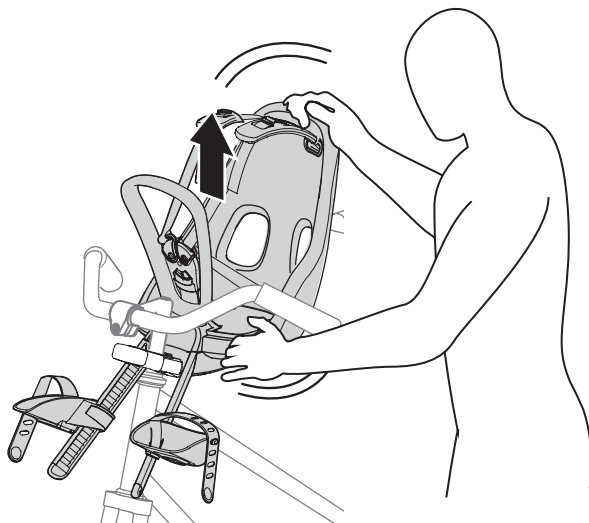

5

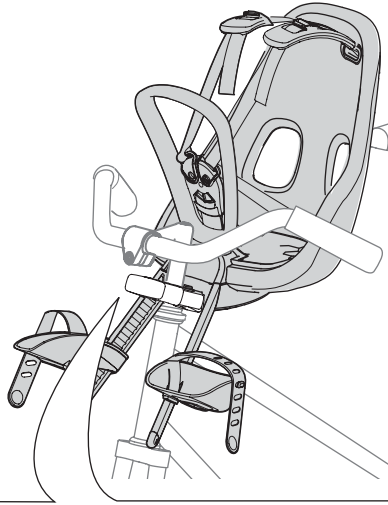

**A**

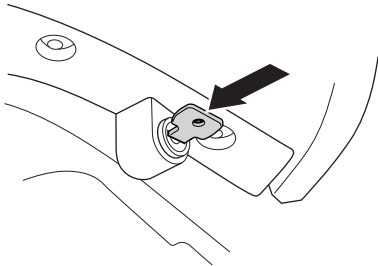

**B**

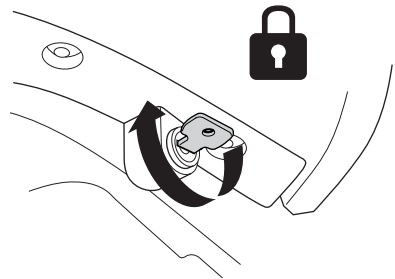

**i**

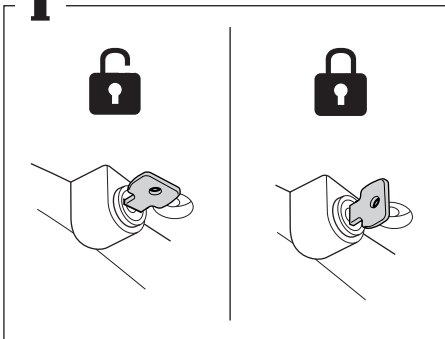

**C**

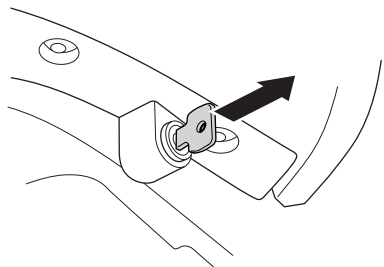



1

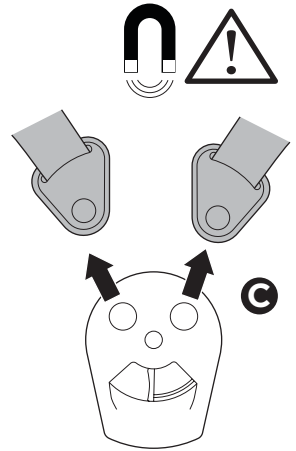
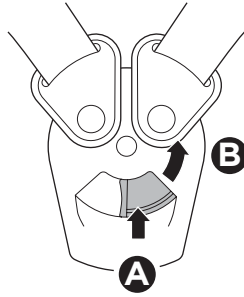
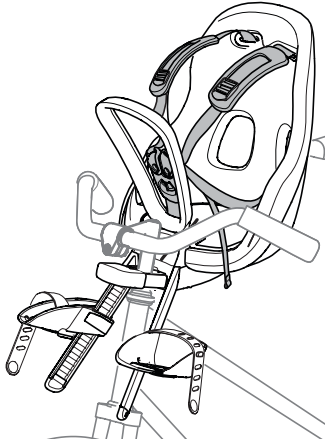

2

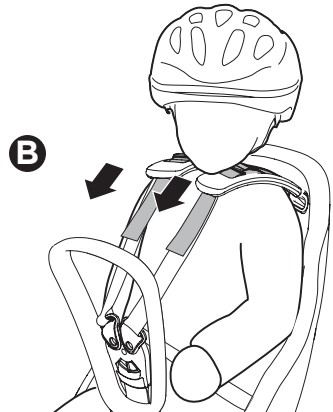
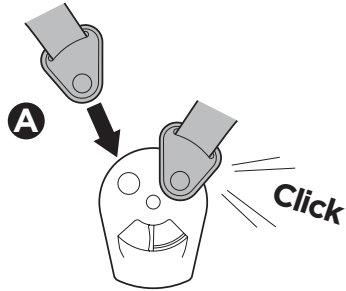
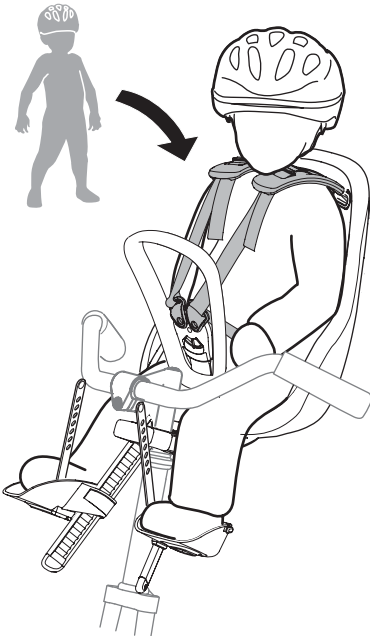

3

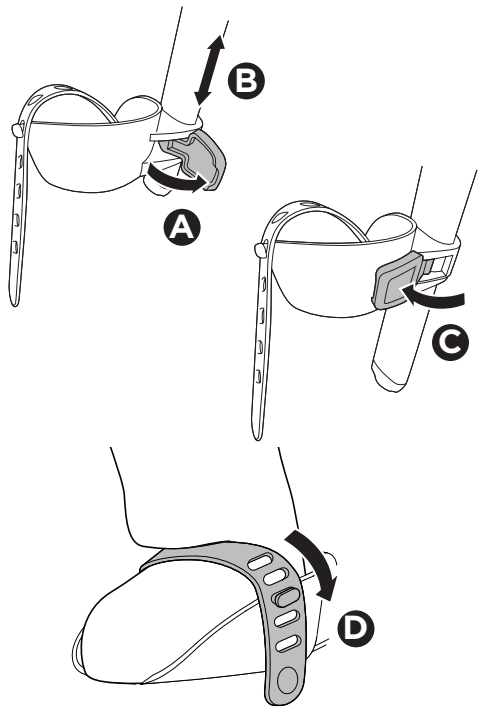

i

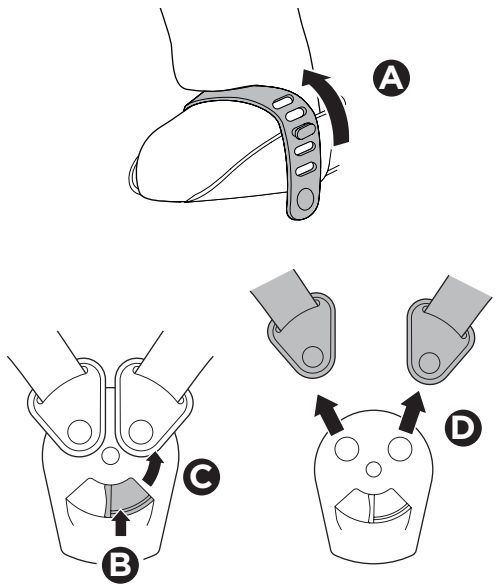
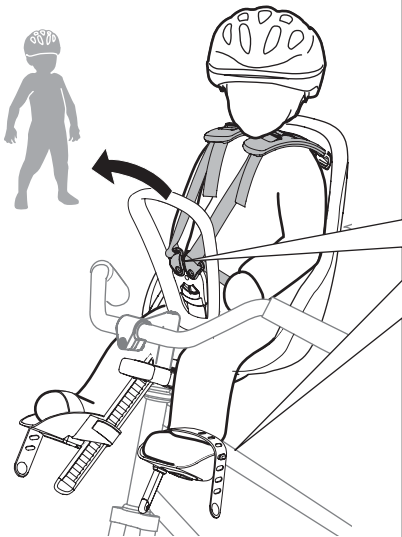

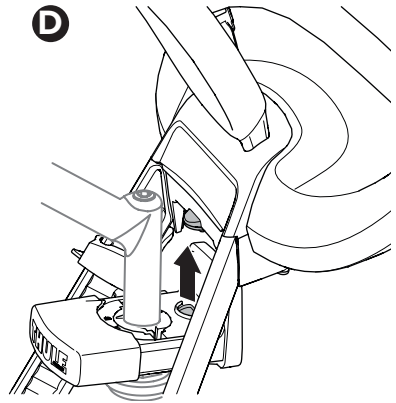
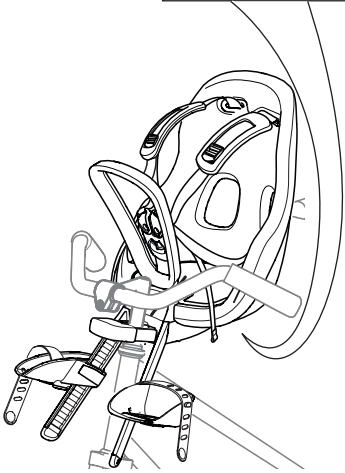
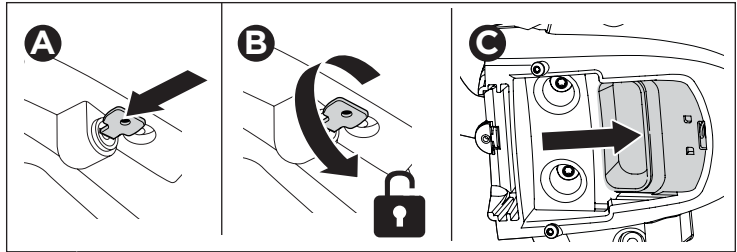
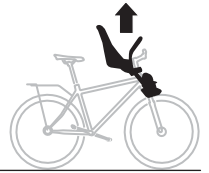

EN Accessories  
FR Accessoires  
ES Accesorios  
DE Zubehör  
NL Accessoires  
PT Acessórios  
IT Accessori  
SV Tillbehör  
DK Tilbehør  
NO Tilbehør  
FI Lisävarusteet  
IS Aukabúnaður

ET Tarvikud  
LV Piederumi  
LT Priedai  
RU Аксессуары  
UK Акcesopria  
PL Akcesoria  
CS Příslušenství  
HU Kiegészítők  
RO Accesorii  
SK Príslušenstvo  
SL Dodatna oprema  
BG Аксесоари

HR Dodatna oprema  
EL Αξεσουάρ  
TR Aksesuarlar  
MT Aċcessorji

אביזרים HE  
الملحقات AR

ZH (CN) 附件  
ZH (TW) 配件  
JA アクセサリー  
KO 액세서리  
TH อุปกรณ์เสริม  
MS Aksesori

## Thule Yepp Raincover

12020971



## Thule Yepp Mini SlimFit Adapter

12080402



## Thule Yepp Mini Windscreen

12020906

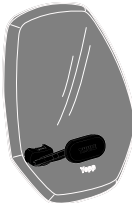

## Thule Yepp Mini Handlebar Padding

12020901



## Thule Yepp Mini Handlebar Padding Miffy

12020902

