

GO RHINO®

INSTALLATION INSTRUCTIONS

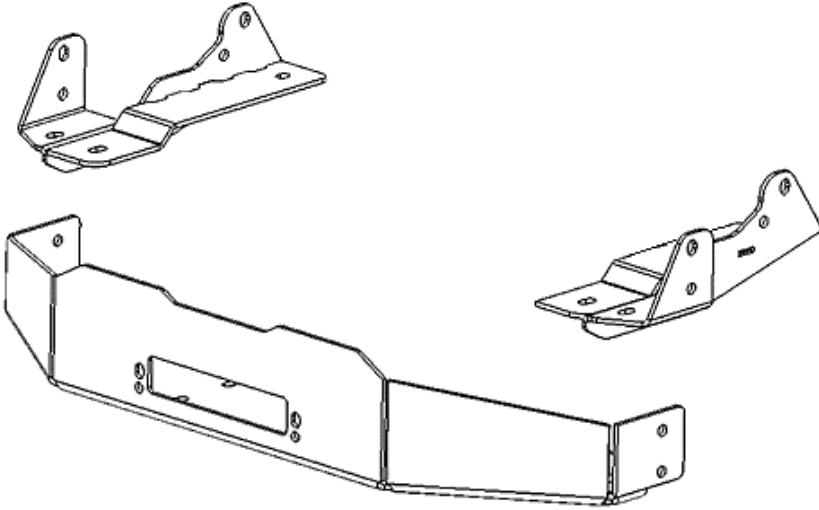

PART NO.

●31761T

PRODUCT DESCRIPTION:

● Go Rhino! 3000 Series Winch Mount Kit

APPLICATION:

● Chevrolet Silverado 1500 (Excludes models with Safety Package- Safety Package II)

PRODUCT SAFETY & LEGAL DISCLAIMER

- **IMPORTANT READ ALL INSTRUCTIONS CAREFULLY BEFORE INSTALLING, FAILURE TO DO SO MAY CAUSE PERSONAL INJURY OR DAMAGE TO PRODUCT AND/OR PROPERTY.**
- **Review the product package and contents prior to beginning the installation.** Take care when opening the packaging and removing items. If a return is needed you will want to return the product in its original packaging if possible.
- This instruction guide is provided as a GENERAL installation guide, some vehicles vary dimensionally and may require additional steps.
- Test fit the product on the vehicle prior to any third party modifications and or finishing. The manufacturer and/or distributors do not accept responsibility for third party charges, labor and or third part replacement modifications. Some modifications may void the factory warranty.
- Exercise due-diligence when installing this product. The manufacturer and distributors of this product do not accept any responsibility for vehicle damage or personal injury resulting from the installation of this product. Careless installation and operation can result in serious injury or equipment damage.
- This product is for general off-road use. All liability for installation and use rests with the owner/operator.
- **INSTALLER:** Once installation is complete, please return this guide along with other documentation included in this product back to the consumer for future reference. The manufacturer/distributors of this product do not guarantee this particular version will be available at a later date.

© 2016 Go Rhino Products. All rights reserved

www.gorhino.com

589 W. Apollo St., Brea, CA 92821

P: 888 427 4466



INSTALLATION INSTRUCTIONS

INJURY HAZARD

Please complete a shop and tool inspection prior to beginning the installation.

- Always make sure you have a clean, dry and well lit work area.
- Always remove jewelry, loose fitting clothing and wear protective gloves and eye protection.
- Always use extreme caution when jacking or raising a vehicle for work. Set the emergency brake and use tire/wheel blocks and jack stands. Refer to the vehicle manufacturer hand book. Utilize the vehicle manufacturers designated lifting points.
- Always use appropriate and adequate care in lifting parts during disassembly and installation. Seek help in lifting heavy or large items into place. Utilize jacks and or lifting devices when available.
- Always insure products are secure during disassembly and installation.
- Always wear eye protection and take steps to protect any exposed skin during the installations. Drilling, cutting and grinding plastic and metal may create flying particles that can cause injury.
- Always use extreme caution when drilling, cutting and or grinding on a vehicle. Thoroughly inspect the area to be drilled, on both sides of material, prior to modification and relocate any objects that may become damaged.
- Always assemble and tighten all fasteners per the installation instructions.
- Always route electrical cables carefully. Avoid moving parts, parts that may become hot and rough or sharp edges.
- Always insulate and protect all exposed wiring and electrical connections.

MAINTENANCE AND CARE

- Always perform regular inspections and maintenance on mounts and related fasteners.
- Periodically check and tighten all fasteners.
- Stripped, fractured, or bent fasteners must be replaced.
- After washing the vehicle make sure to fully dry all surfaces.
- In areas with cold temperatures make sure to wash the product often to remove harmful materials used on road ways.
- Never use abrasive cleaners or polish compounds. Clean with a gentle soap and water. If you use wax use a non-abrasive automotive wax such as pure carnauba wax.

WARNING

Some products have been designed to work together with factory rear sensor systems, factory forward facing sensor systems and factory air bags.

- Installation of some of these products may alter the factory sensor system performance.
- Factory sensors may read shackles or hooks protruding from the fairlead and or tow hooks.
- All sensor testing is completed by Go Rhino Products and or third party testing labs on modified vehicles.
- Sensor sensitivity, factory sensor housing, orientation, and operating conditions are all variables that will influence functionality of the sensors.
- Installation of some product may effect the factory air bag systems.
- Some products allow the use of third party products such as winches, shackles, hooks, etc. Follow the respective manufacturers operating instructions for use with our products.
- Make sure to fully understand the product, it's intended use and operation prior to use.
- Above all... be safe!

GO RHINO®

INSTALLATION INSTRUCTIONS

PARTS INCLUDED IN THIS LIST:

| ITEM | QTY. | PART NUMBER | DESCRIPTION | ITEM | QTY. | PART NUMBER | DESCRIPTION | TORQUE |
|------|------|-------------|------------------|------|------|-------------|-----------------------------|-----------|
| R | 2 | 370200AA | 3/8" T-Bolt | V | 4 | | 1/2" x 1 1/2" Carriage Bolt | 75-ft-lbs |
| S | 2 | AST-RPR07 | 3/8" Lock Washer | W | 4 | AST-RPR06 | 1/2" Lock Washer | |
| T | 2 | AST-RP12 | 3/8" Flat washer | X | 4 | AST-RP06 | 1/2" Flat Washer | |
| U | 2 | AST-TU43 | 3/8" Hex Nut | Y | 4 | AST-TU05 | 1/2" Hex Nut | |

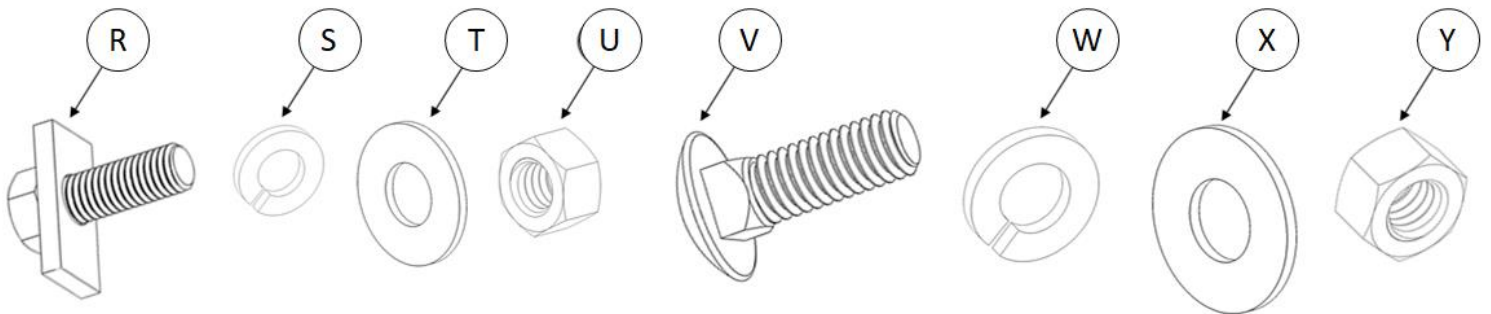

Note: The 3000 Series Step Guard installation instructions PARTS INCLUDED IN THIS LIST items are also referenced throughout this instruction sheet.

Go Rhino recommends you, the installer, read this installation instruction manual from front to back before installing the product. You may also [click here](#) to view an installation video or visit <http://www.gorhino.com/Installation-Videos>.

TOOLS NEEDED FOR INSTALLATION:

- 10mm, 13mm, 18mm, 9/16" & 3/4" Sockets
- 13mm, 18mm, 9/16" & 3/4" Wrenches
- Ratchet, Ratchet Extensions & Swivel Joint Adapter
- T-10 Torx Bit Socket
- Utility Knife

ESTIMATED TIME FOR INSTALLATION:

90 min

If you need installation service for your new product, call the authorized distributor from whom you purchased the product or an authorized installation service company which can be found by calling toll free 1-888-427-4466

GO RHINO®

INSTALLATION INSTRUCTIONS

PARTS INCLUDED IN THIS LIST:

| ITEM | QTY. | PART NUMBER | DESCRIPTION |
|------|------|-------------|---------------------------|
| 13 | 1 | | Lower Bracket (Passenger) |
| 14 | 1 | | Lower Bracket (Driver) |
| 15 | 1 | | Winch Tray |

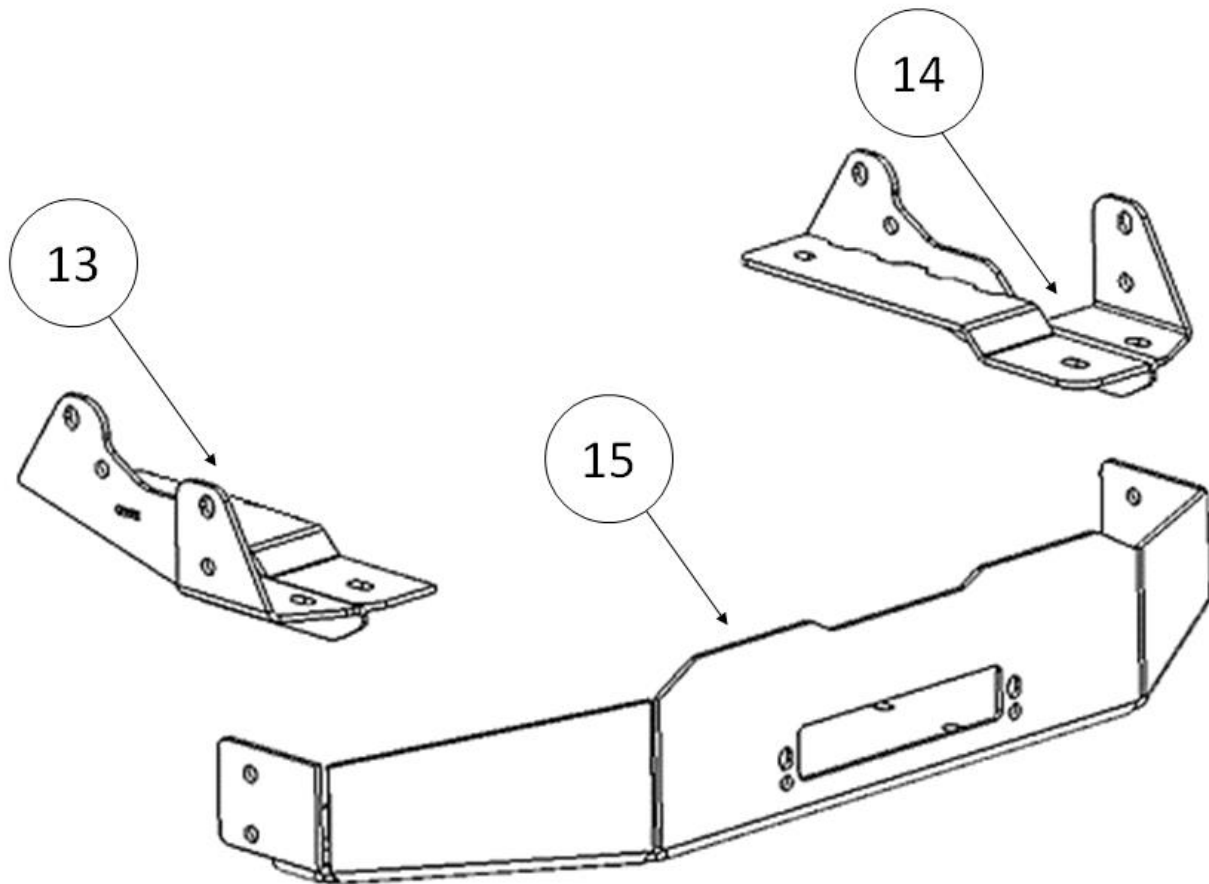

GO RHINO®

INSTALLATION INSTRUCTIONS

Step-1 From underneath the vehicle, remove (1) nut and (2) bolts securing the driver side tow hook to the frame rail using an 18mm socket and 18mm wrench, (Fig 1 & 2).

Step-2 Remove the tow hook by pulling the tow hook out of the frame from the front of the bumper, then remove the foam tow hook access cover from behind the bumper. Note: the tow hooks and foam access covers will not be reinstalled. **Note: If your vehicle is not equipped with factory tow hooks skip step 1 and 2.**

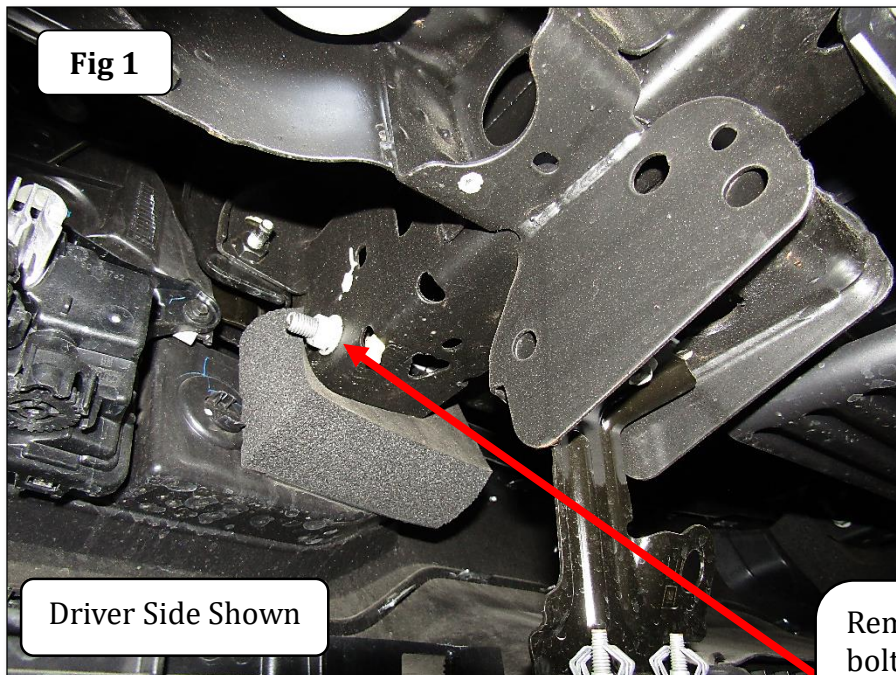

Remove nut and bolts securing the driver side tow hook to the frame.

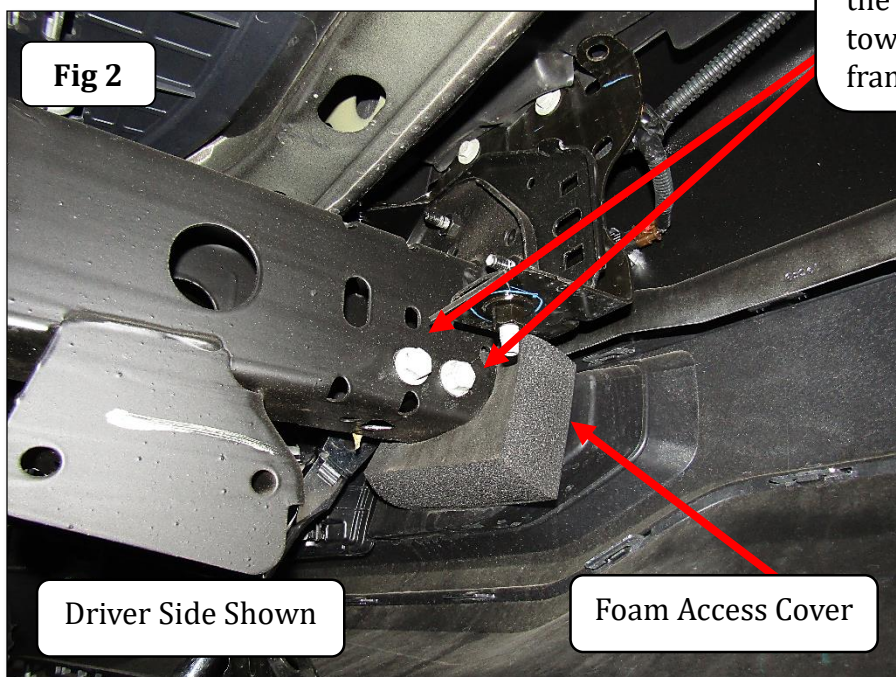

GO RHINO®

INSTALLATION INSTRUCTIONS

Step-3 On each side of the vehicle, cut and remove the area of the bumper cover to clear the mounting brackets, (Fig 3). Repeat for the passenger side.

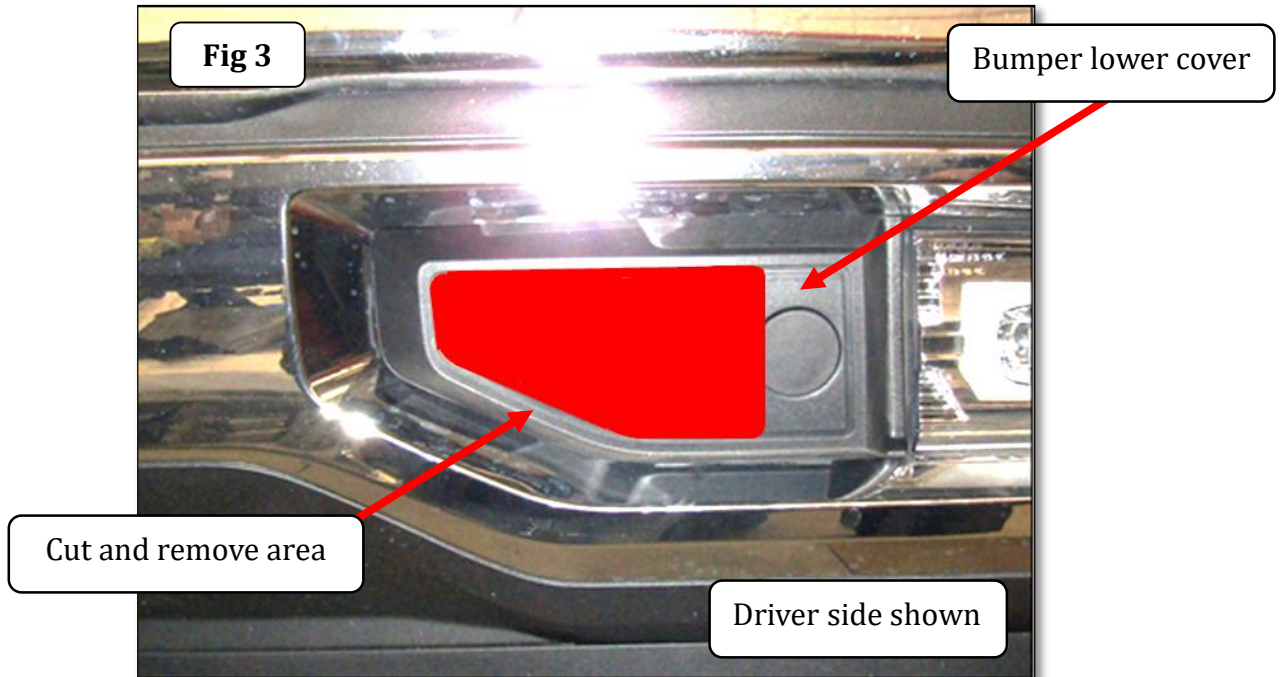

Step-4 From the opening at the end of the driver side frame, position (1) M12 t-bolt inside the frame with the bolt extending out through the obround shape hole on the side of the frame. Install (1) vinyl gasket on the bolt to keep the t-bolt from falling back into the frame. Repeat to install (1) M12 t-bolt in the round hole on the side of the frame, (Fig 4). Note: To ease installation use the supplied pull wire to fish the t-bolts from the opening and out through holes in the frame.

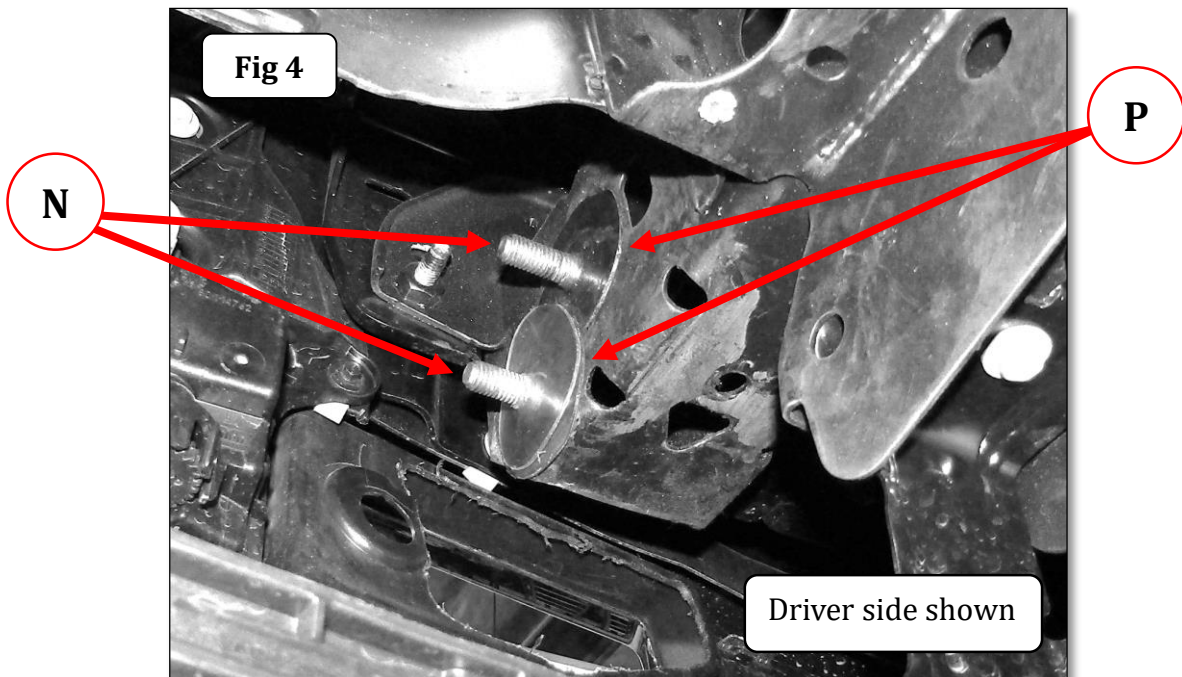

GO RHINO®

INSTALLATION INSTRUCTIONS

Step-5 From the front of the bumper position the driver side lower mounting bracket through the opening in the bumper cover and up to the side of the frame, align the holes in the mounting bracket with the M12 t-bolts, then secure the mounting bracket to the side of the frame using the M12 t-bolts, (2) ½" flat washers, (2) ½" lock washers and (2) M12 hex nuts, (Fig 5 & 6). Do not tighten the nuts.

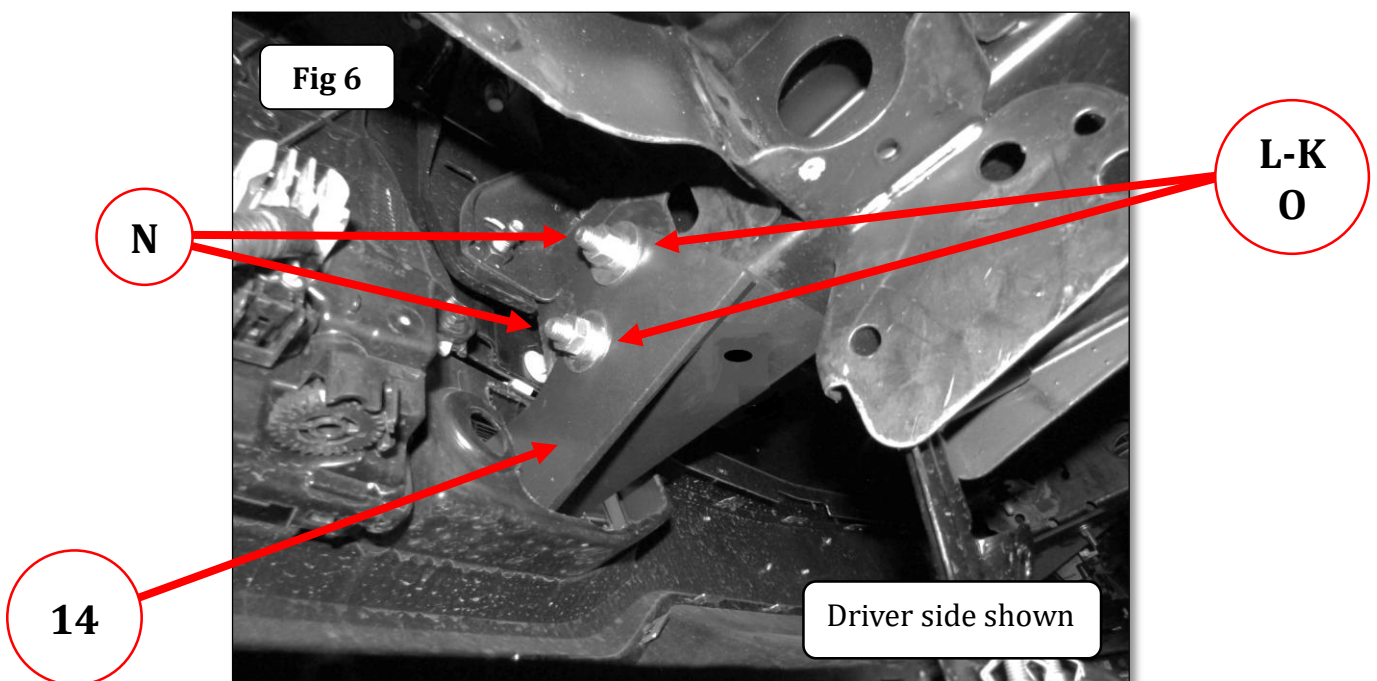
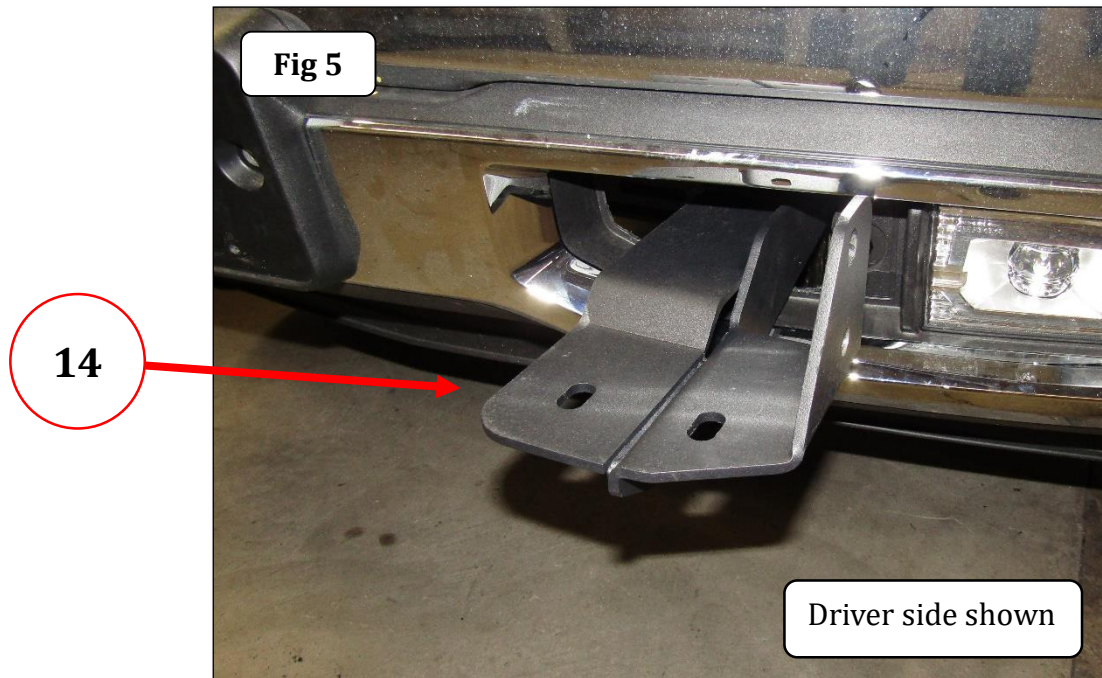

GO RHINO®

INSTALLATION INSTRUCTIONS

Step-6 From the opening at the end of the driver side frame, position (1) 3/8" t-bolt inside the frame with the bolt extending out through the hole in the bottom of the frame and lower mounting bracket. Secure the lower mounting bracket to the bottom of the frame using the 3/8" t-bolt, (1) 3/8" flat washer, (1) 3/8" lock washer and (1) 3/8" hex nut, (Fig 7). Do not tighten the nut. Note: To ease installation use the supplied pull wire to fish the t-bolt from the opening and out through hole in the frame and bracket.

Repeat step 4 through 6 for the passenger side lower mounting bracket.

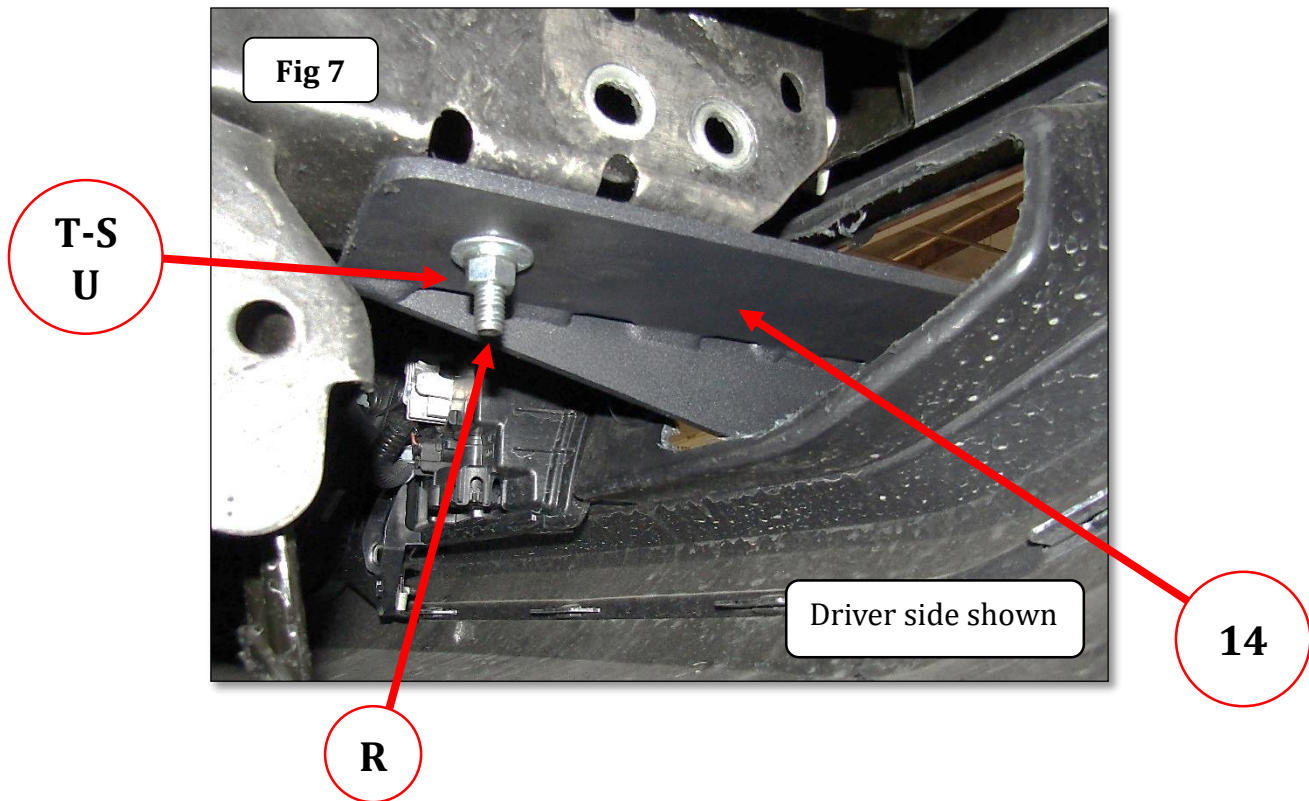

GO RHINO®

INSTALLATION INSTRUCTIONS

Step-7 Open the hood and locate the (10) plastic push pins securing the radiator cover. Using a flat blade screw driver, pry the head of the push pins up, remove push pins and lift radiator cover off. This will allow access to the bolts securing the top of the grille, (Fig 8).

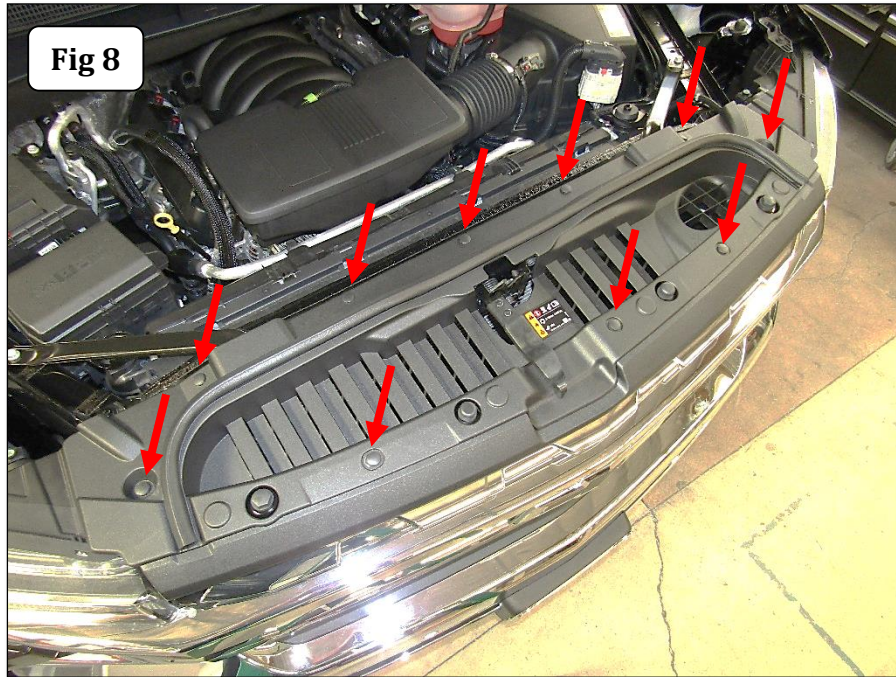

Step-8 Using a 10mm socket and ratchet, remove the (4) screws (2) per side securing the top of the grille, (Fig 9). Working from side to side, gently pull outward on the grille to unsnap the clips by the head lights, and from the sides and center of the grille. Remove the grille from the vehicle.

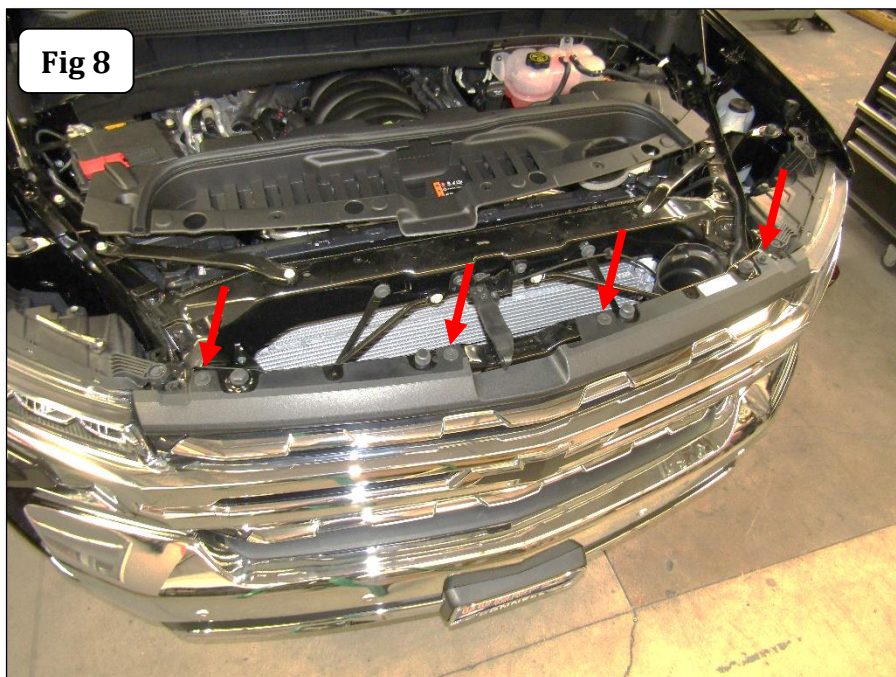

GO RHINO®

INSTALLATION INSTRUCTIONS

Step-9 On each side of the vehicle, locate the (2) hex bolts attaching the top of the bumper to the inner bumper bracket, (Fig 10). Using a 13mm socket remove the (2) hex bolts.

Step-10 Position the passenger side upper mounting bracket behind the inner bumper bracket, align the upper mounting bracket with the holes in the inner bumper bracket and bumper then reinstall the factory hex bolts, (Fig 11). Leave the hex bolts loose. Repeat to install the driver side upper mounting bracket.

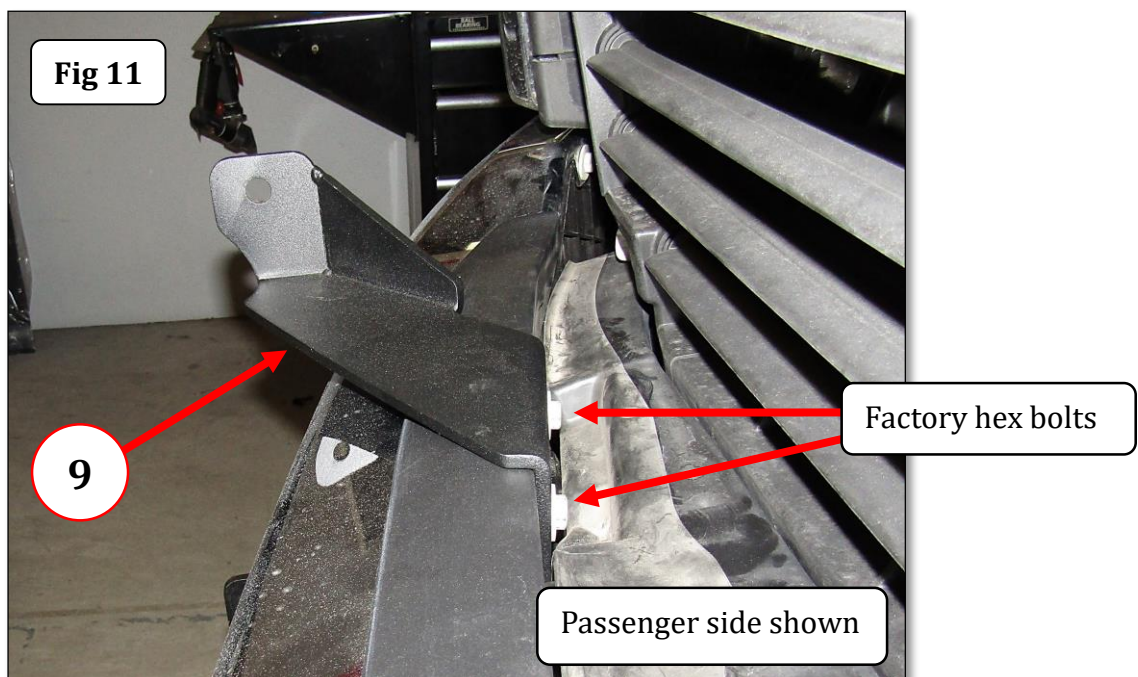
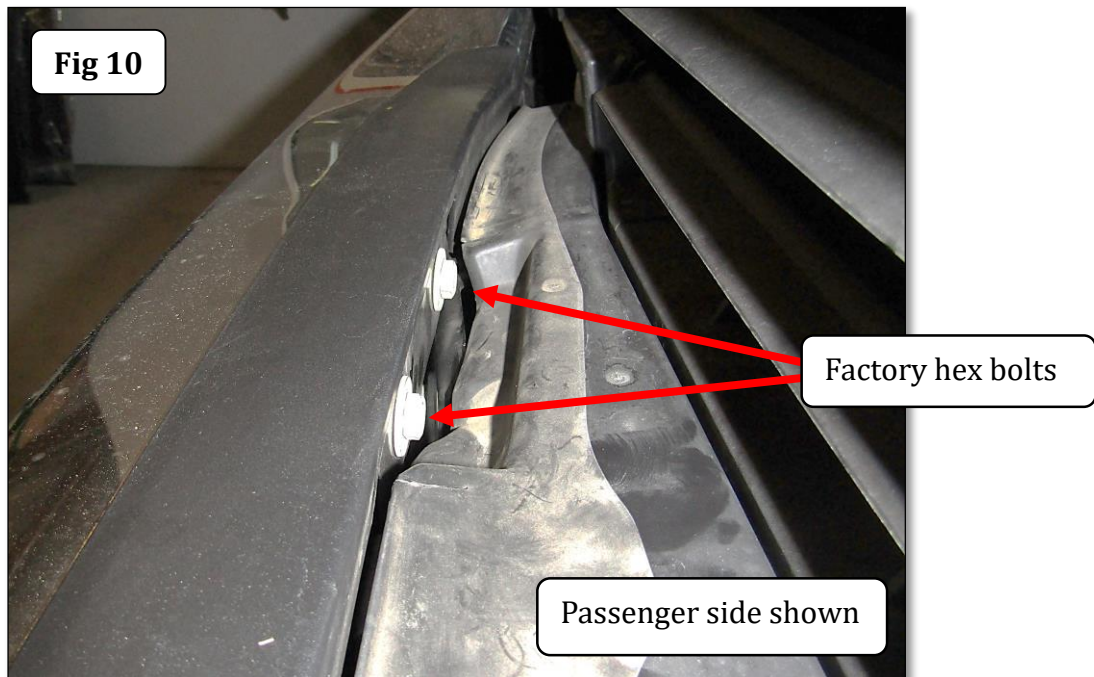

GO RHINO®

INSTALLATION INSTRUCTIONS

Step-11 Adjust the position of the upper mounting brackets so the surface of the upper brackets that attach to the grille guard are $39\frac{7}{16}$ " apart then tighten the factory hex bolts, (Fig 12).

Step-12 Reinstall the grille, radiator cover.

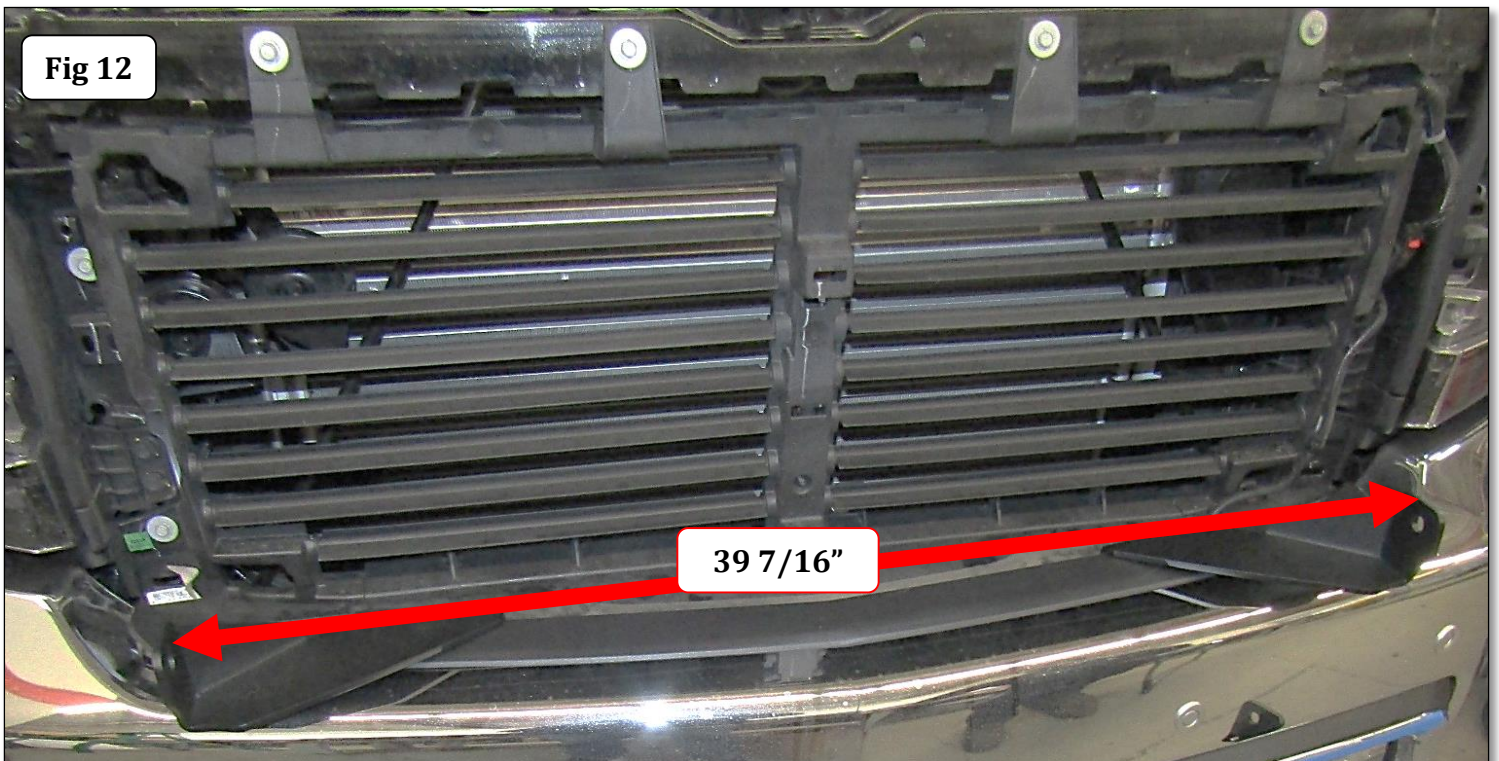

GORRHINO[®]

INSTALLATION INSTRUCTIONS

Step-13 Position the winch tray on top of the lower mounting brackets. Align the holes and secure the winch tray to each lower mounting bracket using (2) ½" x 1 ½" carriage bolts, (2) ½" flat washers, (2) ½" lock washers and (2) ½" hex nuts, (Fig 13 & 14). Leave the nuts and bolts loose for final adjustment. **Note:** If you are installing a winch, place the winch in the winch tray and refer to the winch manufacturer's instructions for installation of the winch and fairlead.

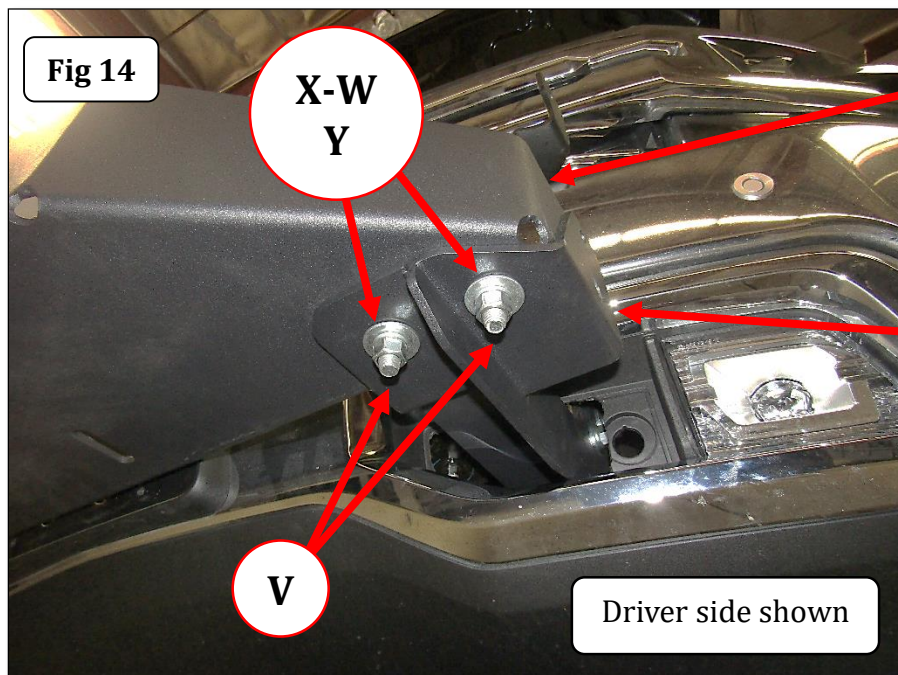
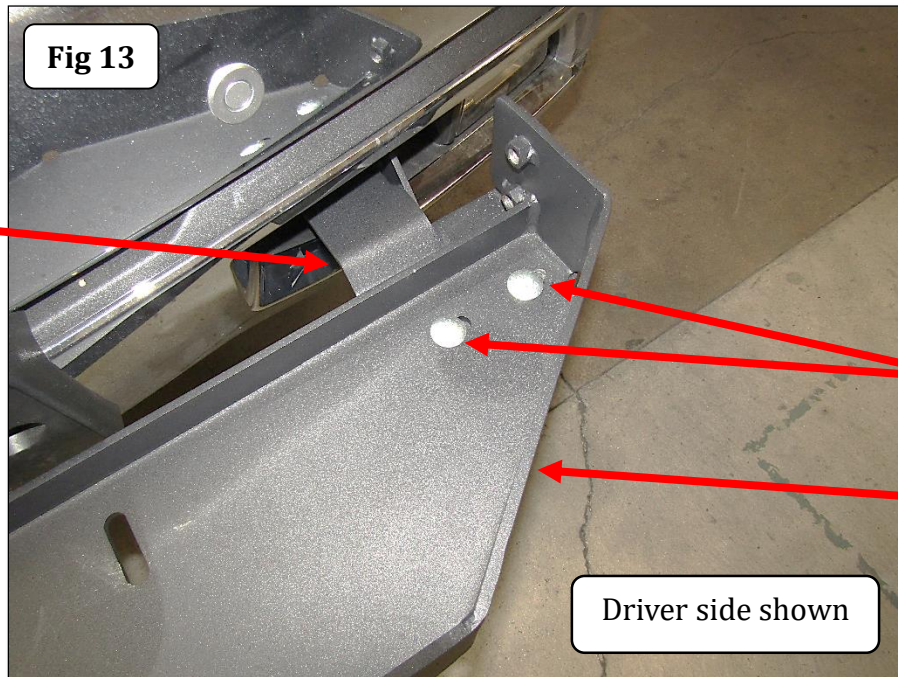

INSTALLATION INSTRUCTIONS

Step-14 Hold one of the grille guard side plates up in position on the outside of the upper and lower mounting brackets.

Step-15 Align the holes in the grille guard side plate with the holes in the upper and lower mounting bracket, and the weld nuts on the winch tray and attach the grille guard to the upper and lower mounting brackets using the supplied $\frac{1}{2}$ " x $1 \frac{1}{2}$ " hex bolts, $\frac{1}{2}$ " flat washers, $\frac{1}{2}$ " lock washers and $\frac{1}{2}$ " hex nut, (Fig 15 & 16).

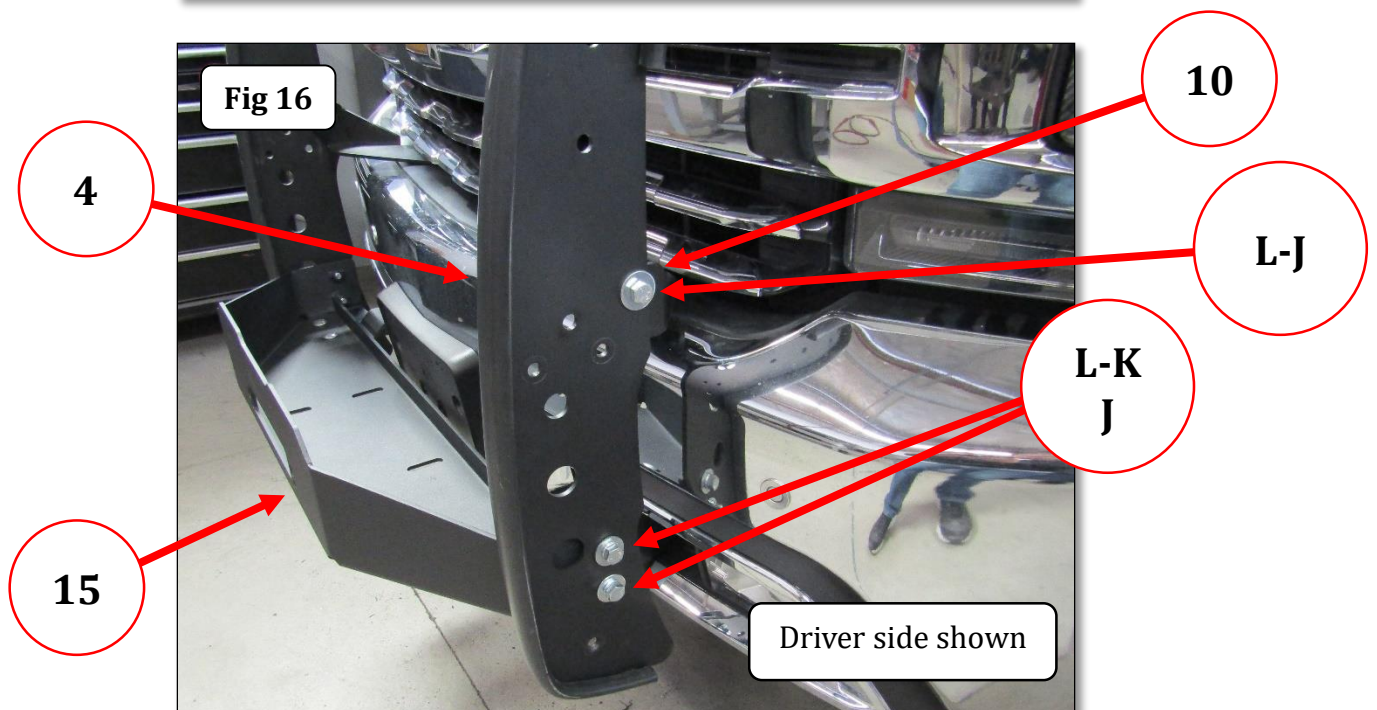
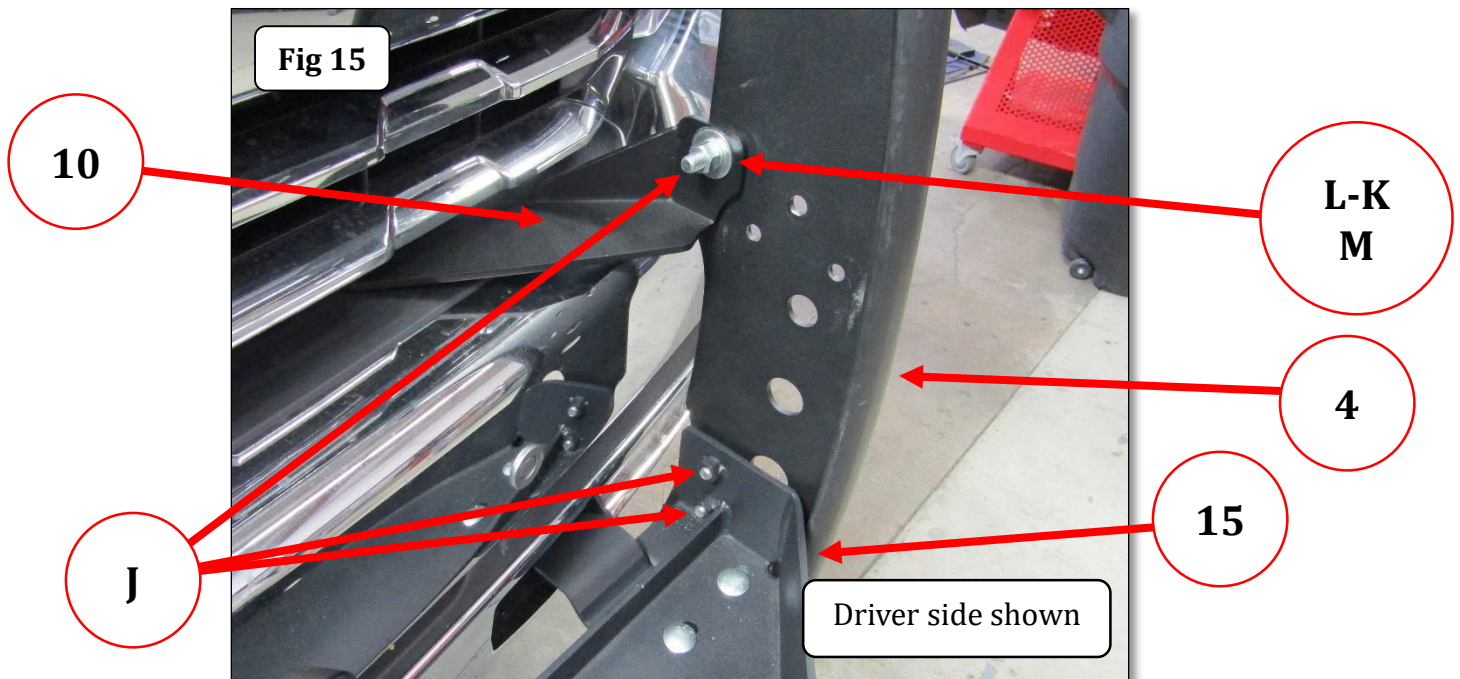

GO RHINO®

INSTALLATION INSTRUCTIONS

Step-16 Position the center plate between the grille guard side plates. Attach the center plate to each side plate using (2) 3/8" X 1 1/4" hex bolts, (4) 3/8" flat washers, (2) 3/8" lock washers and (2) 3/8" hex nuts, (Fig 17 & 18).

Note: Due to the variation in winch dimensions and access to the winch controls, the center plate can be deleted from the installation.

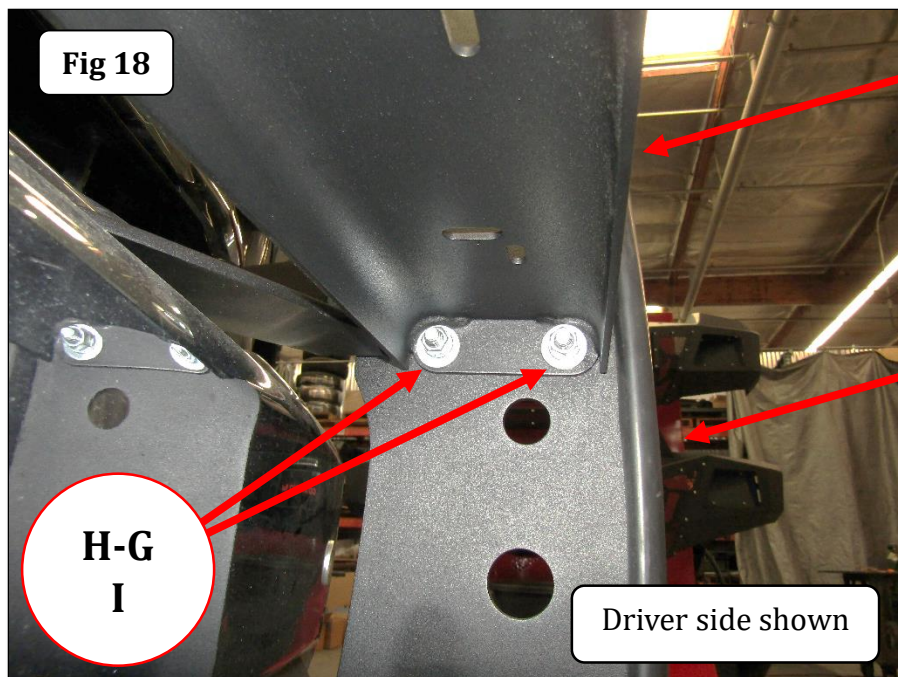
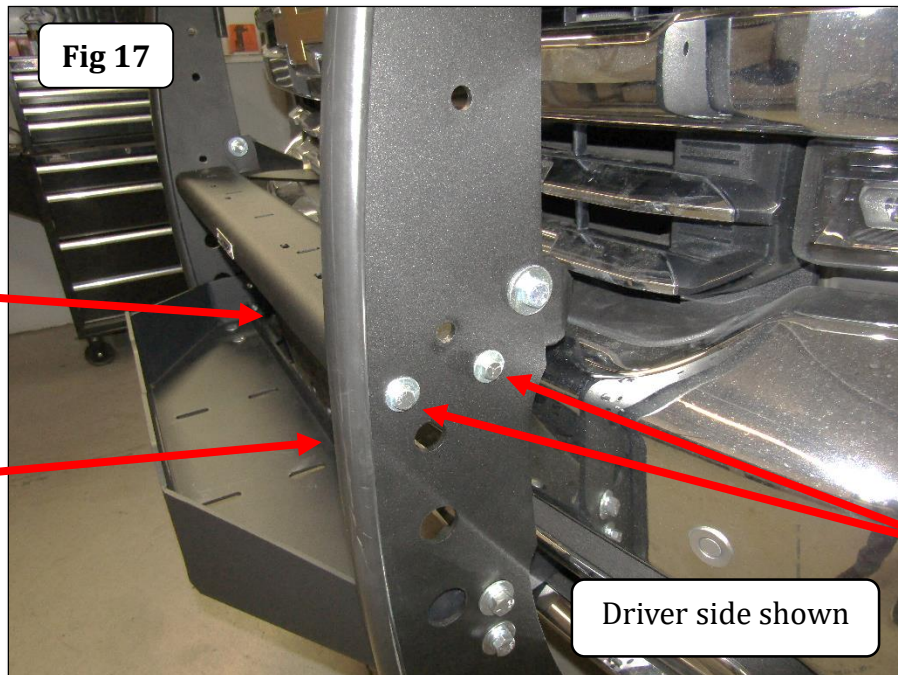

GO RHINO®

INSTALLATION INSTRUCTIONS

Step-17 Position the top tube between the grille guard side plates. Attach the to the top tube to the side plates using (2) 3/8" X 1 1/4" hex bolts, (2) 3/8" lock washers and (2) 3/8" flat washers, (Fig 19 & 20). Align the grille guard center section assembly, then and tighten all nuts and bolts for the grille guard center section assembly, winch tray and mounting brackets.

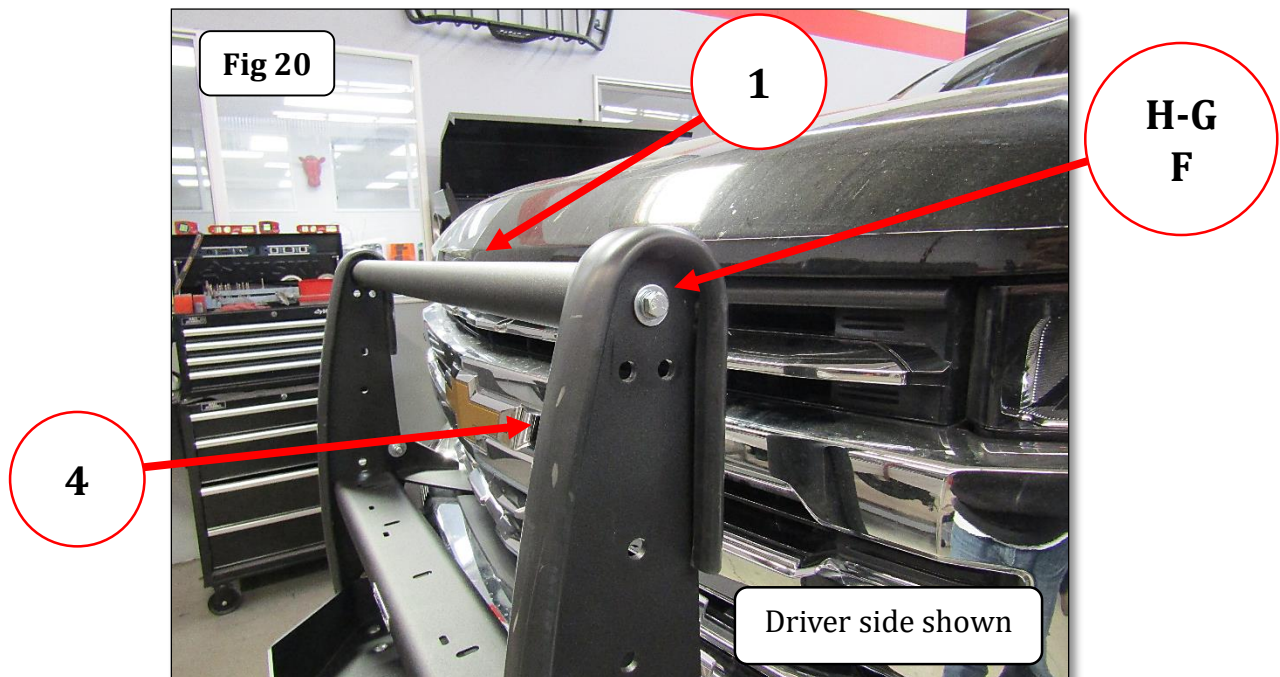
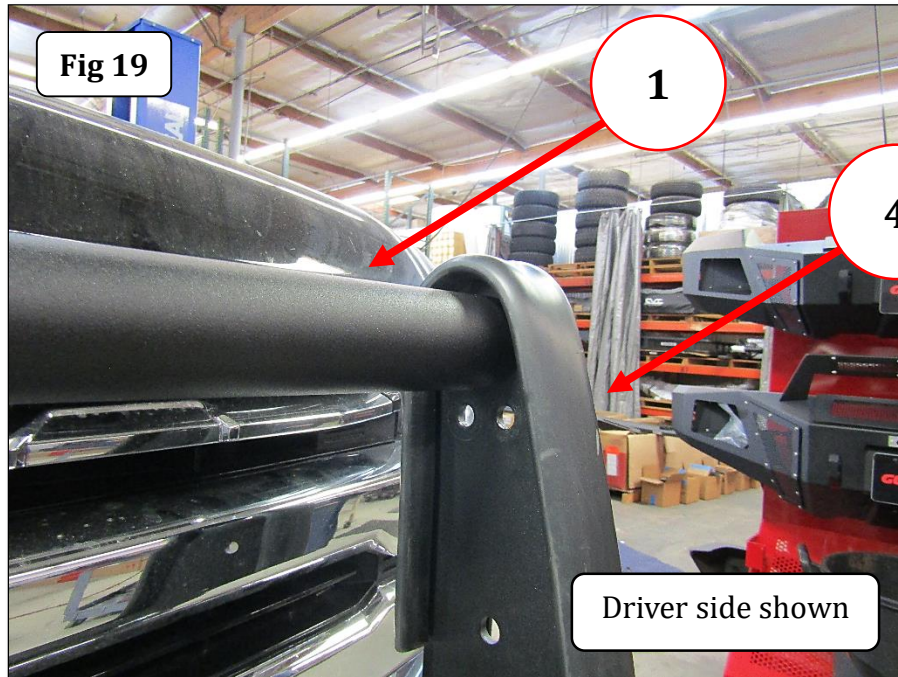

GO RHINO®

INSTALLATION INSTRUCTIONS

Step-18 Position the driver side brush guard up to the grille guard center assembly. Loosely attach the bottom of the brush guard to the grille guard side plate using (1) 3/8" X 1 1/4" hex bolt and (1) 3/8" lock washer. Attach the top of the brush guard to the side plate using (2) 5/16" X 1" button head bolts, (2) 5/16" flat washers and (2) 5/16" lock nuts, (Fig 21 & 22). Do not tighten. Repeat for the passenger side brush guard.

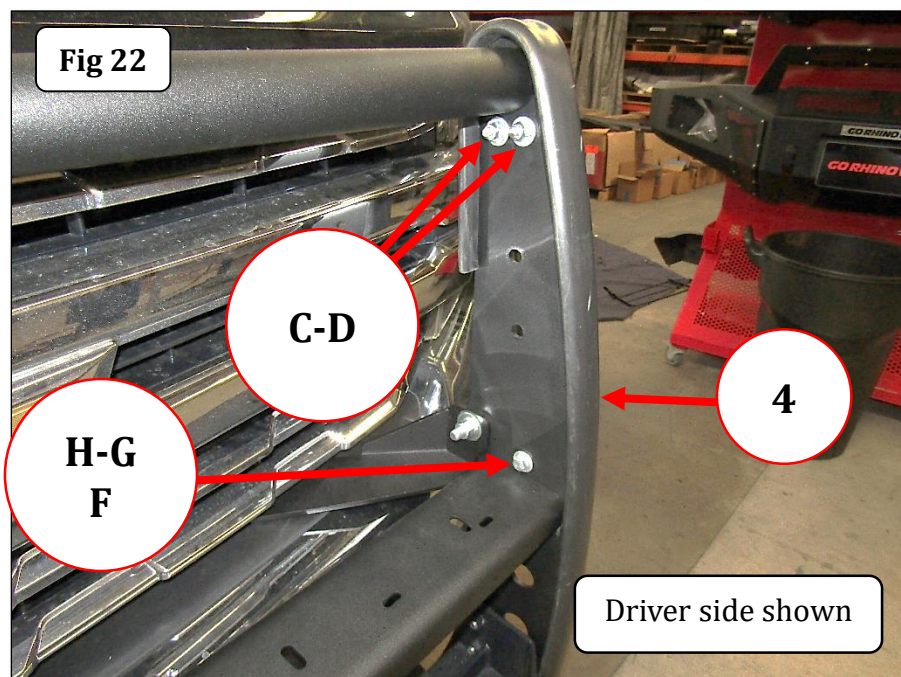
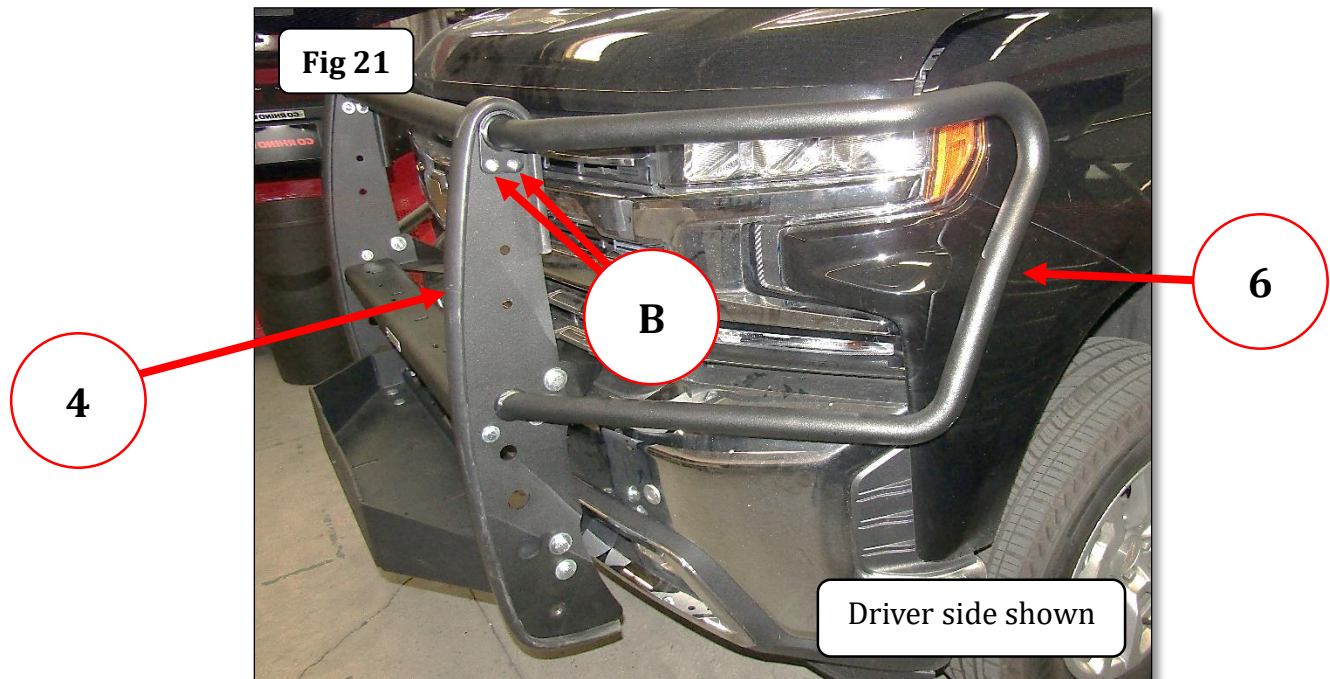

GO RHINO®

INSTALLATION INSTRUCTIONS



Step-19 Attach the driver side headlight protector (not shown) to the brush guard using (1) $\frac{1}{4}$ " x $\frac{3}{4}$ " button head bolt, and the opposite end to the side plate using (2) $\frac{5}{16}$ " x 1" button head bolts, (2) $\frac{5}{16}$ " flat washers and (2) $\frac{5}{16}$ " lock nuts. Repeat for the passenger side headlight protector. Align the grille and brush guard assembly, and tighten all nuts and bolts.



INSTALLATION INSTRUCTIONS

LIMITED WARRANTY

Go Rhino warrants to Buyer that for a period of five (5) years from the date of shipment of the product(s) ("Warranty Period") for black finishes and chrome finishes, that such products will materially conform to the specifications set forth in Go Rhino's specifications in effect as of the date of shipment(s) and will be free from material defects in material workmanship.

Go Rhino warrants to Buyer that for the life of the product(s) from the date of shipment of the product(s) ("Warranty Period") for polished stainless steel finished products purchased after April 2004, that such products will materially conform to the specifications set forth in Go Rhino's specifications in effect as of the date of shipments and will be free from material defects in material workmanship.

Warranty claims must be accompanied with the original invoice and photos of the product. It is the customer's responsibility to clean regularly and protect finish with regular applications of a nonabrasive polish that is compatible with the product's finish.

This warranty covers the cost of the product only and does not include the cost of removal, installation, third party modifications or shipping of the product. In no event shall Go Rhino be liable to buyer or any third party for any damage or harm caused by the product or use thereof, regardless of weather such damages were foreseeable and whether or not Go Rhino has been advised of the possibility of such damages, not withstanding the failure of any agreed or other remedy of its essential purpose. This warranty is void if the product shows signs of alteration, misuse, mishandling, improper care, neglect, improper application and/or damage due to improper installation.

With respect to any such product(s) during the limited warranty period, Go Rhino shall, in its sole discretion, either: (i) provide a one-time repair or replacement of such products (or the defective part) or (ii) credit or refund the price of such products at the pro rata contract rate provided that, if Go Rhino so requests, Buyer shall, at Go Rhino's expense, return such product(s) to Go Rhino. The remedies shall be the Buyer's sole and exclusive remedy and Go Rhino's entire liability for any breach of the limited warrant(ies).

Go Rhino disclaims all other warranties except to the extent that any such warranty cannot be validly disclaimed under applicable law.

Finish Limited Warranty:

Limited lifetime on stainless steel products (after April 2004)

5 year warranty on black powder coat products

5 year warranty on chrome products

This warranty does not cover exposed welds

Finish warranty covers peeling, flaking, or cracking. Washing all finishes regularly with car wash soap and rinsing well with water is the best method for maintaining the finish on your products. You must also protect the finish with nonabrasive automotive wax on a regular basis. The use of any compound which contains abrasives becomes a self-defeating exercise as the compound scratches the finish and opens it to corrosion. The use of harsh chemicals used to remove bugs and tar may also cause the finish to fail and should be avoided.

If you are unsatisfied with your purchase please contact the establishment you purchased the product from.

If you need to place a warranty claim or need assistance, the Go Rhino customer service team will answer any questions you may have. Please contact the Go Rhino customer service team at 1-888-427-4466 during normal business hours Monday thru Friday 7 am to 5 pm PST. You may also email warranty@gorhino.com. In order to better serve you please provide a copy of the original invoice / receipt, a photo of the issue you are experiencing and a photo of the vehicle the product is installed on.

All warranty returns must have an approved RGA number. The RGA number must be clearly marked on the exterior of the return package. All approved warranty returns must be shipped to Go Rhino Products, 1002 Carriers Drive, Laredo, Texas 78045.

PRODUCT REGISTRATION

Please remember to register your new purchase. You may register your product at www.gorhino.com. Registering your product may help speed any future warranty or customer service inquiries.

Thank you again for purchasing from Go Rhino Products

Please take a few minutes to view additional products for your vehicle and more at GORHINO.com
These installation instructions are available on the Go Rhino web site along with installation videos for many of our products.

www.gorhino.com

www.bigcountryauto.com

www.gorhinopd.com