

GO RHINO®

INSTALLATION INSTRUCTIONS

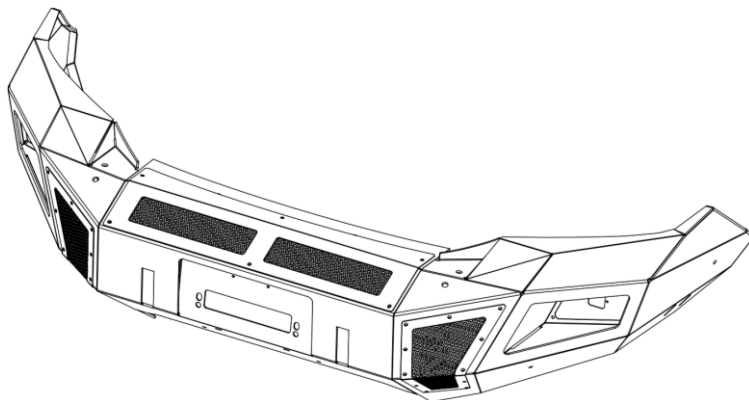

PART NO.

- 24256T

PRODUCT DESCRIPTION:

- FRONT BUMPER REPLACEMENT

APPLICATION:

- NISSAN NP300

PRODUCT SAFETY & LEGAL DISCLAIMER

- **IMPORTANT READ ALL INSTRUCTIONS CAREFULLY BEFORE INSTALLING, FAILURE TO DO SO MAY CAUSE PERSONAL INJURY OR DAMAGE TO PRODUCT AND/OR PROPERTY.**
- **Review the product package and contents prior to beginning the installation.** Take care when opening the packaging and removing items. If a return is needed you will want to return the product in its original packaging if possible.
- This instruction guide is provided as a GENERAL installation guide, some vehicles vary dimensionally and may require additional steps.
- Test fit the product on the vehicle prior to any third party modifications and or finishing. The manufacturer and/or distributors do not accept responsibility for third party charges, labor and or third part replacement modifications. Some modifications may void the factory warranty.
- Exercise due-diligence when installing this product. The manufacturer and distributors of this product do not accept any responsibility for vehicle damage or personal injury resulting from the installation of this product. Careless installation and operation can result in serious injury or equipment damage.
- This product is for general off-road use. All liability for installation and use rests with the owner/operator.
- **INSTALLER:** Once installation is complete, please return this guide along with other documentation included in this product back to the consumer for future reference. The manufacturer/distributors of this product do not guarantee this particular version will be available at a later date.

© 2016 Go Rhino Products. All rights reserved

www.gorhino.com

589 W. Apollo St., Brea, CA 92821

P: 888 427 4466



INSTALLATION INSTRUCTIONS

INJURY HAZARD

Please complete a shop and tool inspection prior to beginning the installation.

- Always make sure you have a clean, dry and well lit work area.
- Always remove jewelry, loose fitting clothing and wear protective gloves and eye protection.
- Always use extreme caution when jacking or raising a vehicle for work. Set the emergency brake and use tire/wheel blocks and jack stands. Refer to the vehicle manufacturer hand book. Utilize the vehicle manufacturers designated lifting points.
- Always use appropriate and adequate care in lifting parts during disassembly and installation. Seek help in lifting heavy or large items into place. Utilize jacks and or lifting devices when available.
- Always insure products are secure during disassembly and installation.
- Always wear eye protection and take steps to protect any exposed skin during the installations. Drilling, cutting and grinding plastic and metal may create flying particles that can cause injury.
- Always use extreme caution when drilling, cutting and or grinding on a vehicle. Thoroughly inspect the area to be drilled, on both sides of material, prior to modification and relocate any objects that may become damaged.
- Always assemble and tighten all fasteners per the installation instructions.
- Always route electrical cables carefully. Avoid moving parts, parts that may become hot and rough or sharp edges.
- Always insulate and protect all exposed wiring and electrical connections.

MAINTENANCE AND CARE

- Always perform regular inspections and maintenance on mounts and related fasteners.
- Periodically check and tighten all fasteners.
- Stripped, fractured, or bent fasteners must be replaced.
- After washing the vehicle make sure to fully dry all surfaces.
- In areas with cold temperatures make sure to wash the product often to remove harmful materials used on road ways.
- Never use abrasive cleaners or polish compounds. Clean with a gentle soap and water. If you use wax use a non-abrasive automotive wax such as pure carnauba wax.

WARNING

Some products have been designed to work together with factory rear sensor systems, factory forward facing sensor systems and factory air bags.

- Installation of some of these products may alter the factory sensor system performance.
- Factory sensors may read shackles or hooks protruding from the fairlead and or tow hooks.
- All sensor testing is completed by Go Rhino Products and or third party testing labs on modified vehicles.
- Sensor sensitivity, factory sensor housing, orientation, and operating conditions are all variables that will influence functionality of the sensors.
- Installation of some product may effect the factory air bag systems.
- Some products allow the use of third party products such as winches, shackles, hooks, etc. Follow the respective manufacturers operating instructions for use with our products.
- Make sure to fully understand the product, it's intended use and operation prior to use.
- Above all... be safe!

GO RHINO®

INSTALLATION INSTRUCTIONS

PARTS INCLUDED IN THIS LIST:

ITEM	QTY.	DESCRIPTION	ITEM	QTY.	DESCRIPTION	ITEM	QTY.	DESCRIPTION
1	1	Frame Bracket (driver)	10	1	Skid plate	19	2	7/16 x 4" Hex Bolt
2	1	Frame Bracket (passenger)	11	2	Vent Covers (pre installed)	20	2	7/16" Hex nut
3	1	Auxiliary Bracket (driver)	12	2	Light Pod Plates (pre installed)	21	4	7/16" Flat Washer
4	1	Auxiliary Bracket (passenger)	13	2	1/2" x 4" Hex Bolt	22	2	7/16" Lock washer
5	1	Auxiliary Bracket Support (driver)	14	10	1/2" x 1 1/2" Hex bolt	23	8	3/8 x 1" Hex bolt
6	1	Auxiliary Bracket Support (passenger)	15	6	1/2" x 1 1/2" Carriage Bolt	24	6	3/8" Hex nut
7	1	License Plate Bracket	16	20	1/2" Flat Washer	25	14	3/8" Flat Washer
8	1	Bumper Shell	17	18	1/2" Lock Washer	26	8	3/8" Lock Washer
9	1	Winch Tray	18	6	1/2" Hex Nut	27		

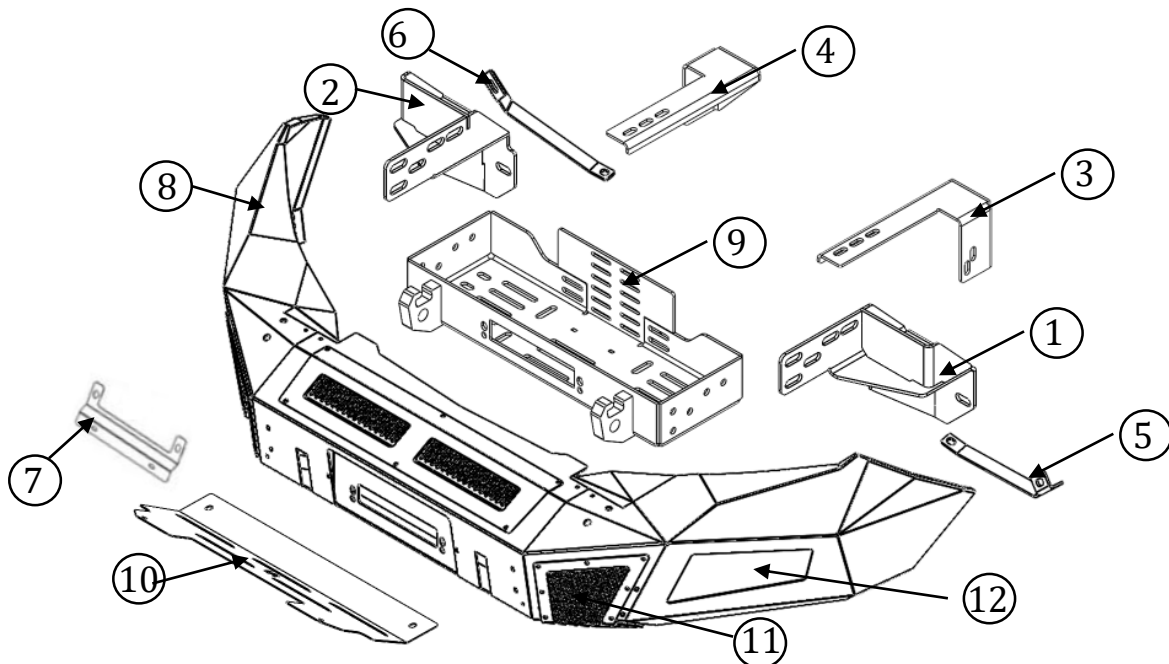

Go Rhino recommends you, the installer, read this installation instruction manual from front to back before installing the product. You may also [click here](http://www.gorhino.com/Installation-Videos) to view an installation video or visit <http://www.gorhino.com/Installation-Videos>.

TOOLS NEEDED FOR INSTALLATION:

- 3/4" and 11/16" Socket & Wrench
- 10mm and 12 mm Socket & Wrench
- 17mm Socket & Wrench
- 9/16" and 5/8" Socket & Wrench
- Slotted Blade Screwdriver
- Ratchet & Extension

ESTIMATED TIME FOR INSTALLATION:

2 Hours

If you need installation service for your new product, call the authorized distributor from whom you purchased the product or an authorized installation service company which can be found by calling toll free 1-888-427-4466

GORRHINO®

Step-1 Begin the installation on the top of the vehicle, remove all screws and tree clip securing the plastic cover. (PICTURE 1) Remove the plastic cover.

Step-2 Remove all screws and tree clip securing the front grille. (PICTURE 2,3 & 4) Remove the grill.

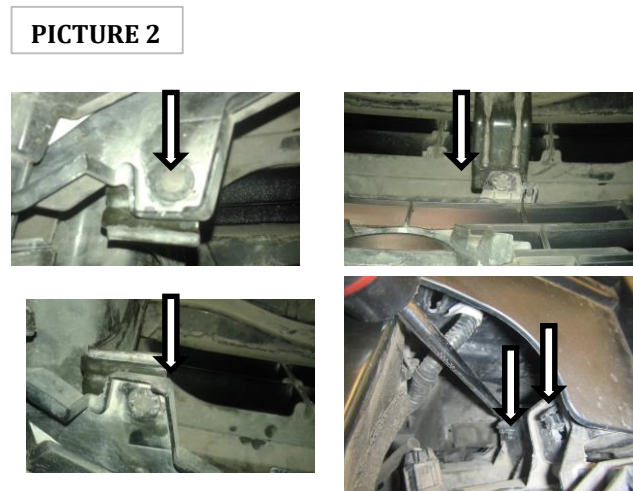
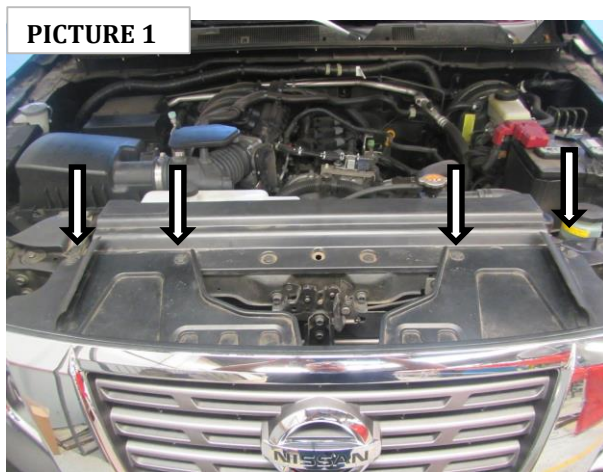

Step-3 If equipped, disconnect the factory fog lights wiring harness from the fog light.

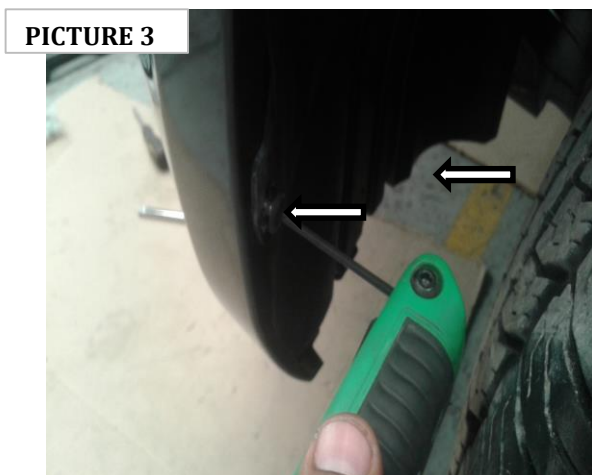

GO RHINO®

INSTALLATION INSTRUCTIONS

Step-4 Remove the front sections fender liner from the bumper. Remove the all screws and tree clip securing the plastic bumper. (PICTURE 5 & 6).

Step-5 If equipped with front park assist, disconnect the sensor wiring pig tail from the vehicle wiring harness.

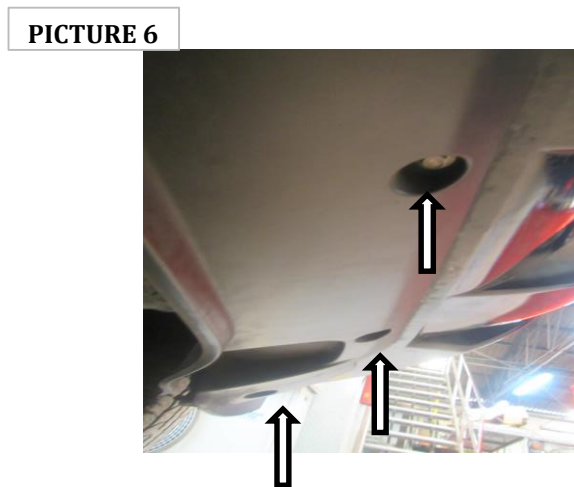

Step-6 Remove the screws securing bumper end. Passenger side and driver side. (PICTURE 7). With assistance remove the bumper from the vehicle. (PICTURE 8).

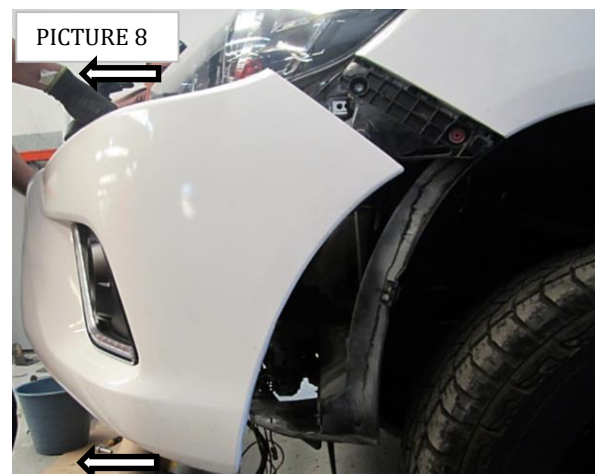
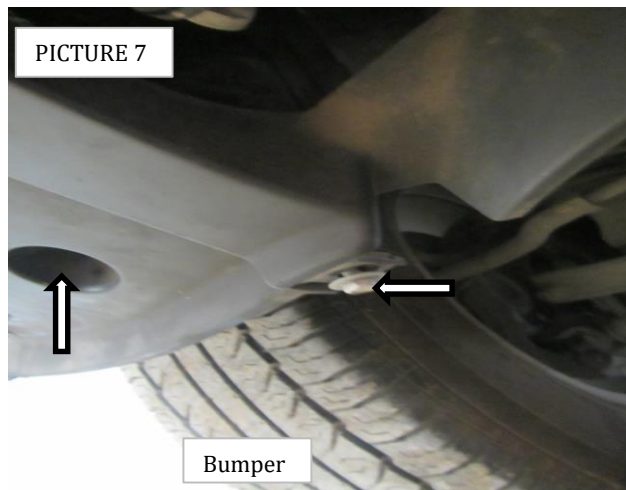

GO RHINO®

INSTALLATION INSTRUCTIONS

Step-7 Remove the plastic covers from the passenger and driver sides. Also remove the bumper support. (PICTURE 9)

Step-8 Pull the plastic cover toward front to the vehicle. (PICTURE 10)

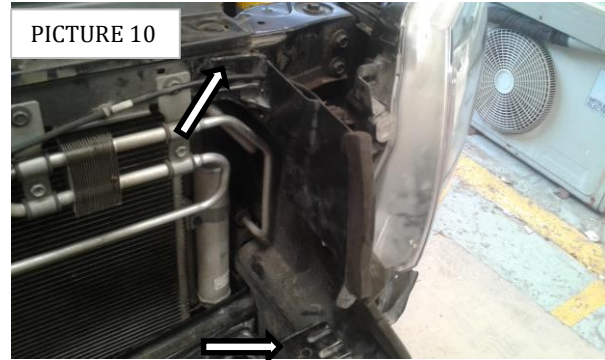
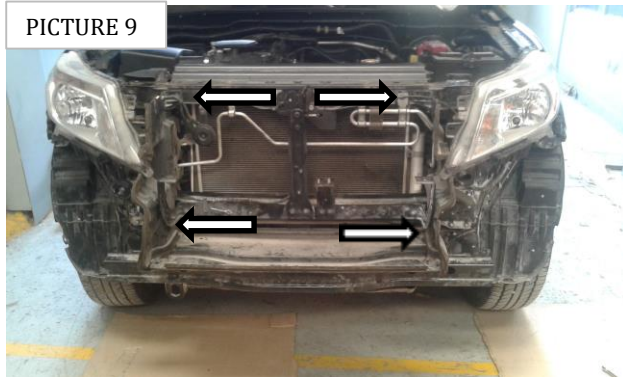

Step-9 Locate the plastic side protectors and remove them, driver side and passenger side. (They will no longer be used). (PICTURE 11). Locate screws that secure the bumper support (2) per side and remove them. (PICTURE 12)

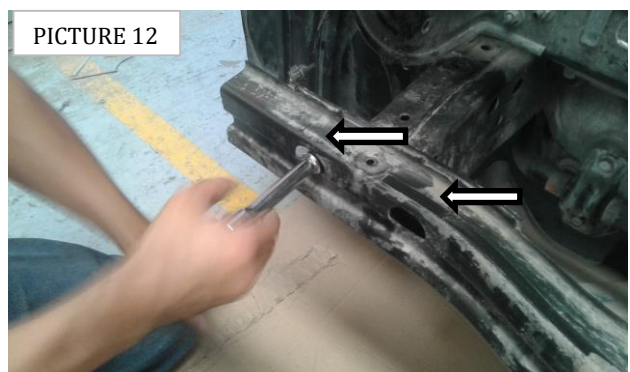
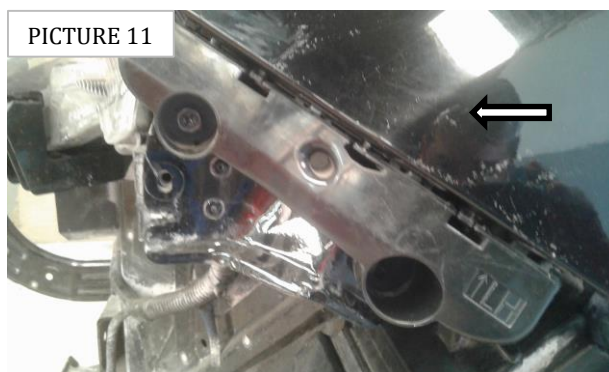

GO RHINO®

Step-10 Position the main bracket in the where you removed the bumper support. Secure the brackets using the nuts removed, and (2) 3/8 x 1 1/4" hex head bolt, (2) 3/8" flat washer, (2) 3/8" lock washer, and (2) 3/8" hex nut per side. **(PICTURE 13 & 14).**

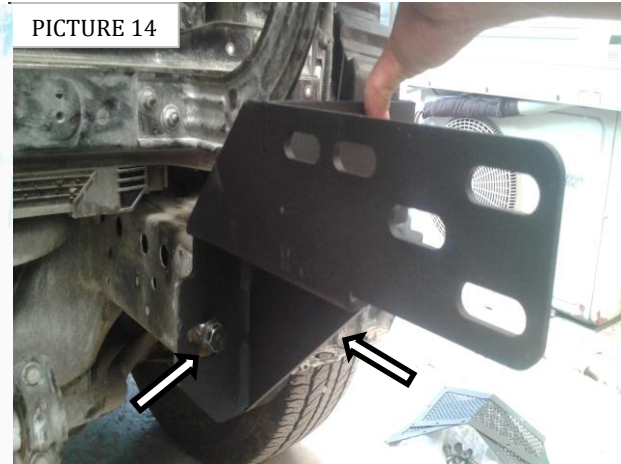

Step-11 Position the auxiliary bracket in the frame. Secure the brackets using (1) 1/2 x 4" hex head bolt, (2) 1/2" flat washer, (1) 1/2" lock washer, (1) 1/4" and (1) 1/2" hex nut. (1) 7/16" x 4" hex head bolt, (2) 7/16" flat washer, (1) 7/16" lock washer, (1) 7/16" hex nut. **(PICTURE 15 & 16).**

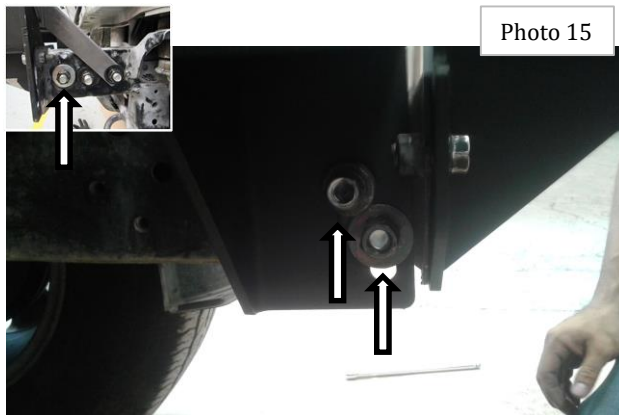

GO RHINO®

INSTALLATION INSTRUCTIONS

Step-12 Position the mounting plate / Winch tray on top of the extension brackets. Secure the mounting plate / Winch tray to each frame bracket using (2) ½ x 1 ½" carriage bolt, (2) ½" flat washer, (2) ½" lock washer and (2) ½" hex nuts, and to each extension bracket using (3) ½ x 1 ½" carriage bolts, (3) ½" flat washer, (3) ½" lock washer and (3) ½" hex nut, **(PICTURE 17 & 18)**.

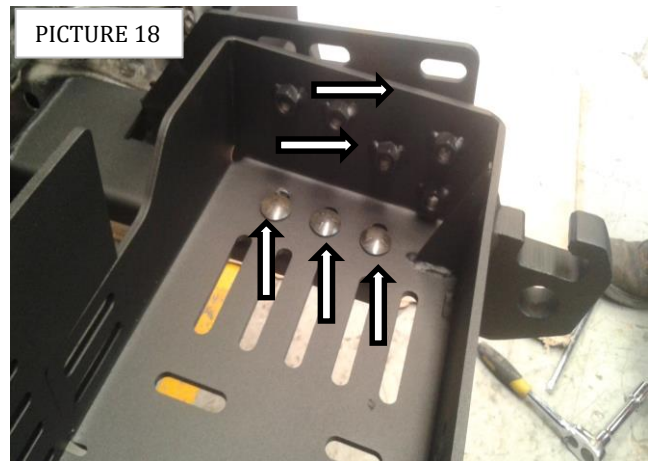
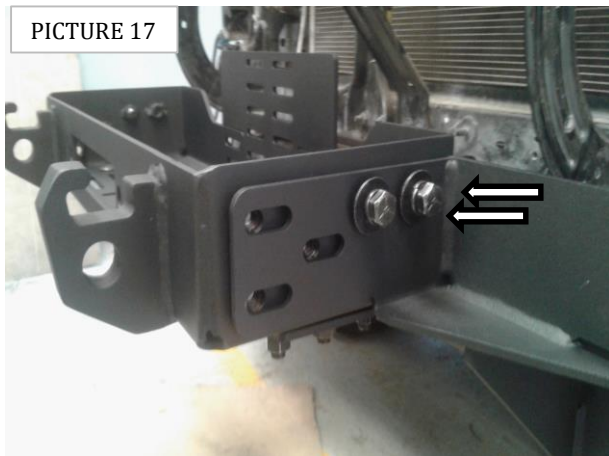

Step-13 Adjust the mounting plate / Winch tray and brackets to the forward position, center and level the mounting plate / Winch tray with the vehicle frame then tighten all factory hex nuts and supplied nuts and bolts securing the mounting plate / Winch tray and frame brackets. Do not install the fairlead at this time.

If you are installing a winch, place the winch in the mounting plate / Winch tray and refer to the winch manufacturer's instructions for installations. Do not install the fairlead at this time.

GO RHINO®

INSTALLATION INSTRUCTIONS

Step-14 With assistance lift the bumper shell up to the vehicle, align the holes in the bumper shell brackets with the weld nuts on the mounting plate / Winch tray and secure the bumper shell to each side of the mounting plate / Winch tray using (3) $\frac{1}{2}$ x $1\frac{1}{2}$ " hex head bolt, (3) $\frac{1}{2}$ " lock washer, and (3) $\frac{1}{2}$ " flat washer, (**PICTURE 19 & 20**).

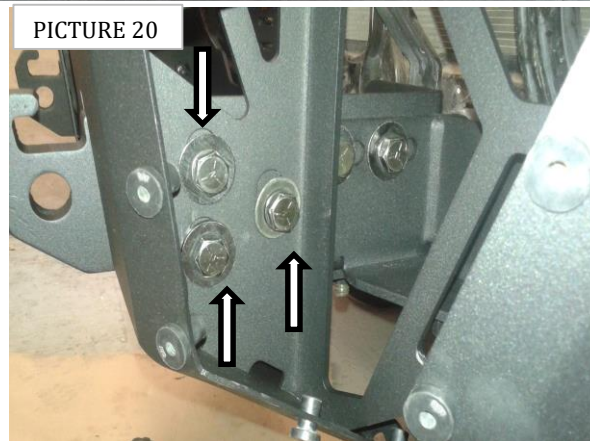

Step-15 Secure the rear auxiliary bracket to the frame using $\frac{1}{2}$ x $3\frac{1}{2}$ " hex head bolt previously installed. And secure the rear auxiliary bracket to the main bracket using (1) $\frac{1}{2}$ x $1\frac{1}{2}$ " hex head bolt, (1) $\frac{1}{2}$ " flat washer, (1) $\frac{1}{2}$ " lock washer, and (1) $\frac{1}{2}$ " hex nut. (**PICTURE 21 & 22**).

Repeat steps for opposite side.

GO RHINO®

Step-16 Position the skid plate on the bumper shell using (2) 3/8 x 1 1/4" hex head bolt, (2) 3/8" flat washer, (2) 3/8" lock washer, and (2) 3/8" hex nut. Secure the skid plate bracket to the frame using (1) 1/2 x 3 1/2" hex head bolt previously installed, and secure the skid plate bracket to the skid plate using (2) 3/8 x 1 1/4" hex head bolt, (2) 3/8" flat washer, (2) 3/8" lock washer, and (2) 3/8" hex nut. (**PICTURE 23 & 24**).

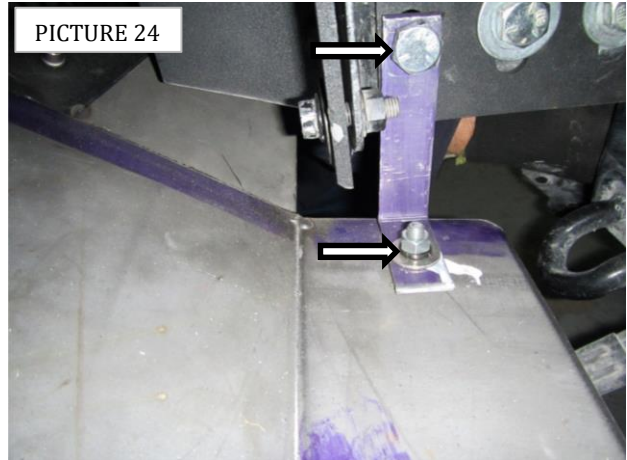

Step-17 Secure the auxiliary side bracket to the frame using the bumper shell using (1) 1/2 x 3 1/2" hex head bolt previously installed. Attach the opposite side end of the auxiliary side bracket to the bumper shell bracket using (1) 1/2 x 1 1/2" hex head bolt, (2) 1/2" flat washer, (1) 1/2" lock washer, and (1) 1/2" hex nut.(**PICTURE 25 & 26**).

Repeat steps for opposite side

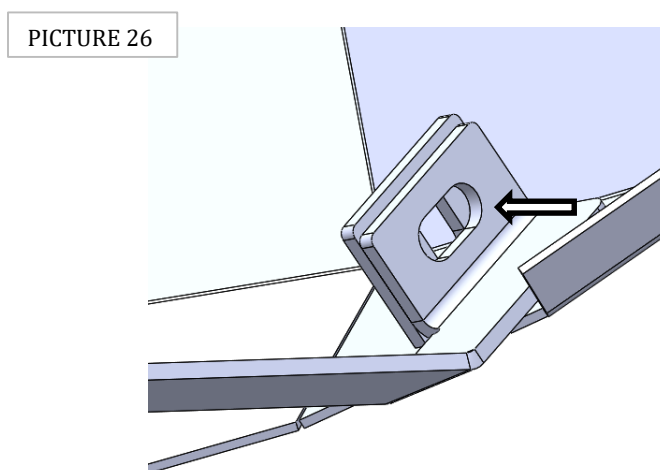

GO RHINO®

INSTALLATION INSTRUCTIONS

Step-19 Slide all the tabs on the grille using a screwdriver to remove the grille from the plastic bumper. Reinstall the grille on the vehicle using the hardware previously removed. (PICTURE 27 & 28).

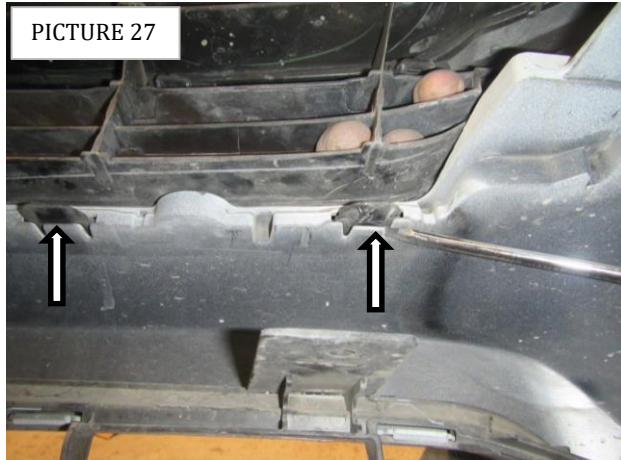

Step-20 Cut thru the lower covers approximate 3" from the upper end. (PICTURE 29 & 30). Reattach the rest of the lower cover in they original position .



GO RHINO®

INSTALLATION INSTRUCTIONS

Step-21 If installing a winch, install the roller fairlead to the bumper shell at this time. Refer to the winch manufacturer's instructions for installation. If installing an optional light bar, install the light bar to the bumper replacement at this time. Refer to the light bar instructions for installation.

Step-22 Install the winch cover and driver and passenger side front vent covers to the bumper shell using the supplied $\frac{1}{4}$ x $\frac{3}{4}$ " button head bolts. (**PICTURE 31**) **NOTE:** Do not over tighten bolts, reference tightening torque (71 in./Lbs.)

Step-23 Install the flush mount light pods to the bumper shell using (4) $\frac{1}{4}$ x $\frac{3}{4}$ " button head bolt and $\frac{1}{4}$ " nylon lock nuts, (**PICTURE 31**)

Step-24 If your state law requires a front license plate, attach the license plate bracket to the holes in the face of the bumper shell, using the supplied $\frac{3}{8}$ bolt, washer and nuts, and the license plate to the (2) obround holes in the license plate bracket using the supplied $\frac{1}{4}$ " bolts and nuts. (**PICTURE 32**).

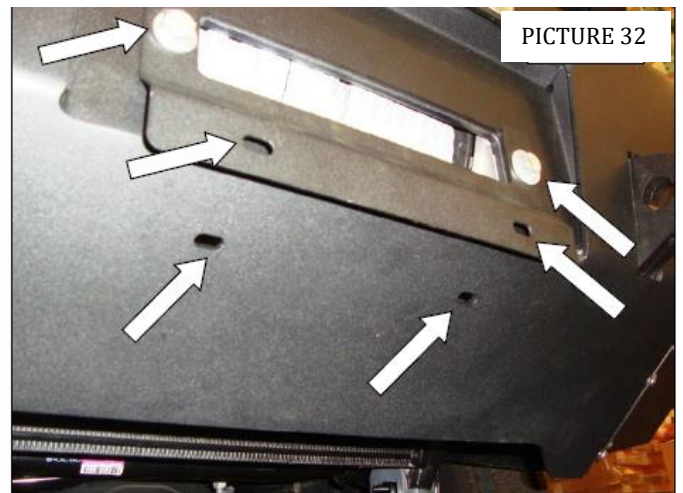
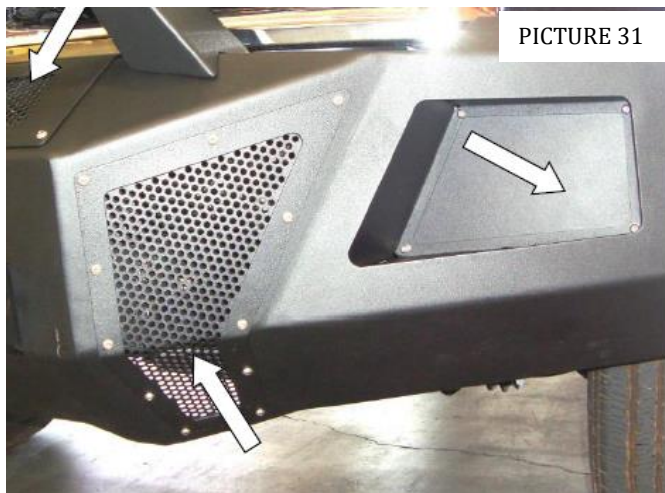

Step-25 If installing a winch, attach the license plate directly to the (2) obround holes in the lower face of the bumper shell using the supplied $\frac{1}{4}$ " bolts and nuts. (**PICTURE 32**).

Remember to check and retighten all factory and supplied nuts and bolts periodically.



INSTALLATION INSTRUCTIONS

LIMITED WARRANTY

Go Rhino warrants to Buyer that for a period of five (5) years from the date of shipment of the product(s) ("Warranty Period") for black finishes and chrome finishes, that such products will materially conform to the specifications set forth in Go Rhino's specifications in effect as of the date of shipment(s) and will be free from material defects in material workmanship.

Go Rhino warrants to Buyer that for the life of the product(s) from the date of shipment of the product(s) ("Warranty Period") for polished stainless steel finished products purchased after April 2004, that such products will materially conform to the specifications set forth in Go Rhino's specifications in effect as of the date of shipments and will be free from material defects in material workmanship.

Warranty claims must be accompanied with the original invoice and photos of the product. It is the customer's responsibility to clean regularly and protect finish with regular applications of a nonabrasive polish that is compatible with the product's finish.

This warranty covers the cost of the product only and does not include the cost of removal, installation, third party modifications or shipping of the product. In no event shall Go Rhino be liable to buyer or any third party for any damage or harm caused by the product or use thereof, regardless of weather such damages were foreseeable and whether or not Go Rhino has been advised of the possibility of such damages, not withstanding the failure of any agreed or other remedy of its essential purpose. This warranty is void if the product shows signs of alteration, misuse, mishandling, improper care, neglect, improper application and/or damage due to improper installation.

With respect to any such product(s) during the limited warranty period, Go Rhino shall, in its sole discretion, either: (i) provide a one-time repair or replacement of such products (or the defective part) or (ii) credit or refund the price of such products at the pro rata contract rate provided that, if Go Rhino so requests, Buyer shall, at Go Rhino's expense, return such product(s) to Go Rhino. The remedies shall be the Buyer's sole and exclusive remedy and Go Rhino's entire liability for any breach of the limited warrant(ies).

Go Rhino disclaims all other warranties except to the extent that any such warranty cannot be validly disclaimed under applicable law.

Finish Limited Warranty:

Limited lifetime on stainless steel products (after April 2004)
5 year warranty on black powder coat products
5 year warranty on chrome products
This warranty does not cover exposed welds

Finish warranty covers peeling, flaking, or cracking. Washing all finishes regularly with car wash soap and rinsing well with water is the best method for maintaining the finish on your products. You must also protect the finish with nonabrasive automotive wax on a regular basis. The use of any compound which contains abrasives becomes a self-defeating exercise as the compound scratches the finish and opens it to corrosion. The use of harsh chemicals used to remove bugs and tar may also cause the finish to fail and should be avoided.

If you are unsatisfied with your purchase please contact the establishment you purchased the product from.

If you need to place a warranty claim or need assistance, the Go Rhino customer service team will answer any questions you may have. Please contact the Go Rhino customer service team at 1-888-427-4466 during normal business hours Monday thru Friday 7 am to 5 pm PST. You may also email warranty@gorhino.com. In order to better serve you please provide a copy of the original invoice / receipt, a photo of the issue you are experiencing and a photo of the vehicle the product is installed on.

All warranty returns must have an approved RGA number. The RGA number must be clearly marked on the exterior of the return package. All approved warranty returns must be shipped to Go Rhino Products, 1002 Carriers Drive, Laredo, Texas 78045.

PRODUCT REGISTRATION

Please remember to register your new purchase. You may register your product at www.gorhino.com. Registering your product may help speed any future warranty or customer service inquiries.

Thank you again for purchasing from Go Rhino Products

Please take a few minutes to view additional products for your vehicle and more at GORHINO.com
These installation instructions are available on the Go Rhino web site along with installation videos for many of our products.

www.gorhino.com

www.bigcountryauto.com

www.gorhinopd.com